



Controller Catalog

Advantage Controls
4700 Harold-Abitz Dr.
Muskogee, OK 74403
Phone: (800) 743-7431
Fax: (888) 686-6212



www.advantagecontrols.com

Contents

Web Advantage	3
MyTechReports.....	3
MegaTron MT Touch Screen Controllers for Towers, Boilers, and Process	4
MegaTron XS Controllers for Towers, Boilers, and Process.....	6
MicroTron Controllers for Towers and Timers	8
NanoTron Controllers (Timers, Tower, Boiler, Corrosion, pH, ORP, and mA input)	9
Cooling Tower Accessories.....	10
Water Meters	10
Zigbee Transmitter.....	10
Bleed-Off Piping Assemblies	11
Corrosion Coupon Racks.....	12
Loop Guard Corrosion Racks	14
Solid Feed Systems.....	15
Prefabricated Systems.....	17
Wall Mounts	18
Controller Mount Boards.....	19
Fully Enclosed Cabinets	20
EVC Systems.....	21
Glycol Feeders for Closed Loop Systems	22
Economy Glycol Feeder	23
Bypass Feeders.....	24
Boiler Accessories	25
Boiler Valve Packages	25
Boiler Valve Stands.....	25
Boiler Trace Panels.....	26
Boiler Valves	27
Sample Cooler.....	27
Specialty Sensors.....	28
Fluorometer	28
Free Chlorine and CLO2 Sensors	29
EchoPod Drum Sensors	30
Leak Detection Sensor	30
Replacement Probes and Parts.....	30
Flow Assembly and Parts	32
 Filtration.....	34
Cellular Packages.....	36
Hand Held Testers	36
Standard Solutions	36
Liquid Level / Alarm Fill Controllers	37
Miscellaneous Products.....	38
Repair Options and Fees.....	39
Manufacturer's Product Warranty.....	39
30 Day Billing Memo Policy	39

Restocking Charge - All items accepted for credit are subject to a restocking fee of 25% of the original sale price. All items returned for credit must be new, unused, undamaged equipment less than 3 months old that is still in production.

Minimum Order - There is a minimum net order amount of \$30.00, excluding shipping.

Please Note - Possession of price list does not ensure right to purchase direct.
Due to continuous improvement of products, prices subject to change without notice.

Web Advantage

Get the optional internet communications card and Web Advantage lets you constantly stay connected to your unit over the internet and get emailed reports automatically sent to you at no charge.

Web Advantage is a totally secure server dedicated to keeping track of all of your internet connected MegaTron units. Any MegaTron equipped with an internet connection option will be monitored 24 hours a day by Web Advantage providing you constant, real time information. Web Advantage allows you to change settings, generate history reports automatically and select who to send email alarm notifications to, should Web Advantage detect any system conditions outside your parameters.

WEBADV-RTF.....WebAdvantage Admin Transfer Fee

Access to Web Advantage has no annual fee! There is simply a connection fee to establish ownership rights. The initial connection fee is included free with the purchase of a MegaTron with communications, giving the original buyer ownership rights also. If a MegaTron's ownership changes from the original buyer, the transfer fee will be charged to establish new ownership rights.

WEBADV-XSCLOUD

XS controllers not on the web and purchased without a communications card can have their USB downloaded data stored on WebAdvantage for a one-time setup charge.

WEBADV-MTCLLOUD

For non-web connected MT controllers, virtual hosting on WebAdvantage and history uploading.

MyTechReports

MyTech Reports is a web-based reporting service that works to keep track of all your service reporting needs. The MyTechReports service allows water treaters and their partners to work together and act on data, from saving lab results and controller data to storing documents such as inspection videos, training material, SDS/PDS sheets, and more. The mobile app is available on Android and iOS, enabling employees to quickly access information from one location. A free trial is available, as well as packaged offerings to meet any business' needs.

MegaTron MT Controllers

A single MT unit can control 1 to 4 systems and have up to 20 control relays. To build a model pick the function(s) needed by the type of probe. Add the code for each function you need for a system. For a multiple system controller list all of the functions of the first system followed by a dash then the functions for the next system. If system two is the same as the first just put (-X2). If the systems 2, 3 and 4 are the same as the first put a (-X4). After all system(s) functions use another dash and list all of the unit options needed. Example: MTCPF3E-CF3E-N4

MegaTron XS Controllers

MegaTron XS units have all the features and functions of the larger MegaTron units in a smaller enclosure with just 5 control relays. To build a model pick the function(s) needed by the type of probe. If building a dual boiler unit put a – after the first system and list the system selections for the second system followed by the whole unit option. Example: XSB2F3-B2-H

Build a MegaTron MT

Model **MT**

Conductivity Control (1 per system max)

C	= TE-4A Standard Tower probe	120 PSI (8.2 bar) @ 125°F (51.6°C)
C0	= Tower Conductivity no probe	
C1	= TE-4ASS Standard Tower probe w/ SS tips	120 PSI (8.2 bar) @ 125°F (51.6°C)
C3	= AH-4ASS 1" MNPT	250 PSI (17.2 bar) @ 140°F (60°C)
C5	= DC-4ASS tank mount	190°F (87.7°C)
C8	= AL-4RTD pure water, 1/2" MNPT, RTD temp	100 PSI (6.8 bar) @ 212°F (100°C)
C10	= DI-4A, 1" MNPT	120 PSI (8.2 bar) @ 125°F (51.6°C)
C11	= CS-4ASS corporation stop probe	75 PSI (5.1 bar) @ 140°F (60°C)
C12	= AL-4ASS pure water, 1/2" MNPT, thermistor	100 PSI (6.8 bar) @ 212°F (100°C)
B	= BE-34BC boiler probe, thermistor, 1" cross	250 PSI (17.2 bar) @ 400°F (204.4°C)
B0	= Boiler conductivity no probe	
B1	= BE-4RTDC boiler probe, RTD temp, 1" cross	250 PSI (17.2 bar) @ 400°F (204.4°C)
B2	= BE-32C probe, no temp comp, 1" cross	250 PSI (17.2 bar) @ 400°F (204.4°C)
B7	= BE-32-SC probe, no temp comp 3/4" cross	250 PSI (17.2 bar) @ 400°F (204.4°C)
B9	= Boiler conductivity with RTD temp; no probe	
D	= DI-27-4A high conductivity range	120 PSI (8.2 bar) @ 125°F (51.6°C)
D1	= TE-4A high conductivity range (0-50,000)	120 PSI (8.2 bar) @ 125°F (51.6°C)

Make-up / Miscellaneous Conductivity (max of 1 per system)

M	= DI-4A Standard Make-up	120 PSI (8.2 bar) @ 125°F (51.6°C)
MA	= Alias make-up input of other make-up reading	
M0	= Make-up / miscellaneous conductivity no probe	
M1	= DI-4ASS	120 PSI (17.2 bar) @ 125°F (51.6°C)
M3	= AH-4ASS 1" MNPT probe	250 PSI (17.2 bar) @ 140°F (60°C)
M4	= TE-4A PVC 3/4" slip tee design	120 PSI (8.2 bar) @ 125°F (51.6°C)
M6	= CS-4ASS corporation stop probe	75 PSI (5.1 bar) @ 140°F (60°C)

pH Control (1 per system max) For dual set point use Q instead of P

P	= TPE-21 Standard Tower	100 PSI (6.8 bar) @ 140°F (60°C)
P0	= pH Control no probe	
P2	= TPE-21 w/ pre amp	100 PSI (6.8 bar) @ 140°F (60°C)
P4	= Tank mounted probe (PE-21 with DPE)	140°F (60°C)
P5	= Tank mount w/ pre amp (PE-21, DPE & RTP-4)	140°F (60°C)
P8	= PE-21SS stainless steel probe 1/2" MNPT	200 PSI (13.8 bar) @ 180°F (82.2°C)
P9	= PE-21SS with pre amp	200 PSI (13.8 bar) @ 180°F (82.2°C)
P11	= PE-11 low ionic probe, 1/2" MNPT	50 PSI (3.4 bar) @ 180°F (82.2°C)
P12	= PE-11 w/ pre amp	50 PSI (3.4 bar) @ 180°F (82.2°C)
P15	= PE-21CS Corp-stop w/ pre amp, 1" FNPT	100 PSI (6.8 bar) @ 165°F (73.8°C)

ORP Control (1 per system max)

R	= TOE-21 Standard Tower	100 PSI (6.8 bar) @ 140°F (60°C)
R0	= ORP Control no probe	
R2	= TOE-21 with preamp	100 PSI (6.8 bar) @ 140°F (60°C)
R4	= Tank mounted probe (OE-21 with DPE)	140°F (60°C)
R5	= Tank mounted ORP w/ pre amp (OE-21, DPE & RTP-4)	140°F (60°C)
R8	= OE-21SS stainless steel probe 1/2" MNPT	200 PSI (13.8 bar) @ 180°F (82.2°C)
R15	= OE-21CS Corp-stop w/ pre amp, 1" FNPT	100 PSI (6.8 bar) @ 180°F (82.2°C)

Temperature Control (2 max / system – Each conductivity uses up one)

T	= TC-1 Standard Tower	120 PSI (8.2 bar) @ 125°F (51.6°C)
T2	= High temp probe	250 PSI (17.2 bar) @ 140°F (60°C)

Feed Timers (max of 5 per system: 28-DAY, PULSE, %, Recycle, LIMIT or POST BLEED)

F1 to F5 (F4 = Four feed timers)

Flow Switches

E	= Standard float style switch PVC assembly	120 PSI (8.2 bar) @ 125°F (51.6°C)
E3	= Paddle flow switch PVC assembly	120 PSI (8.2 bar) @ 125°F (51.6°C)
E4	= Paddle flow switch PVC unassembled, 10' cord	120 PSI (8.2 bar) @ 125°F (51.6°C)
E5	= Paddle switch brass assem. (order rated probes)	250 PSI (17.2 bar) @ 75°F (23.8°C)
E6	= Flow switch connection only with cable	
E8	= Standard float switch PVC unassembled, 10' cord	120 PSI (8.2 bar) @ 125°F (51.6°C)
E9	= Paddle flow switch with SS tee only	250 PSI (17.2 bar) @ 75°F (23.8°C)
E11	= Flow indicator (0-10) with switch, PVC assembly	100 PSI (6.8 bar) @ 125°F (51.6°C)

After all System Card features are selected go to the next page for whole unit options.

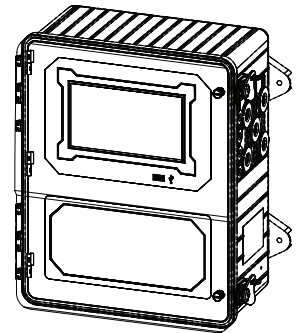

MegaTron MT touch screen units include:

- Communication card
- Built in Wi-Fi
- All card expansion slots

MegaTron MT Whole Unit Options

A	=	Conduit connections, 120-volt relay cards
A1	=	Liquid tights only with 120-volt relay cards
A3	=	Liquid tights only with CE mark, 240 volt relay cards
A5	=	Prewired power cord to On/Off; 120-volt relay boards have no power
A6	=	Korean power cord, no pigtails, 240 volt relay cards
A7	=	Australian power cord, no pigtails, 240 volt relay cards
A8	=	Prewired USA power cord with 1/2" conduit relay connections; 120-volt
A9	=	Prewired USA power cord; no relay board(s)
H7	=	Adds Zigbee base radio
H11	=	Internet card with CAT5 connection and Modbus TCP/IP
H21	=	Internet card with CAT5 connection and BACnet TCP/IP
K	=	Additional control relays (K, K2, K3) don't exceed 20 relays total
N4	=	Four 4-20mA Inputs
N8	=	Eight 4-20mA Inputs
O4	=	Four 4-20mA Isolated Outputs
O8	=	Eight 4-20mA Isolated Outputs
V4	=	Additional 24 VDC power supply in lower section
W	=	10 auxiliary flow meter inputs

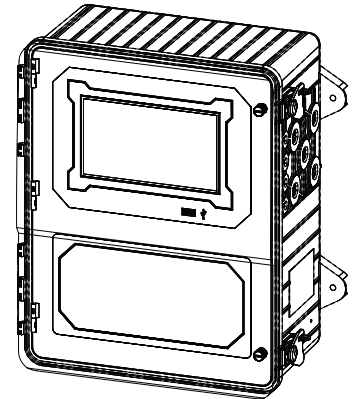

- Notes:**
1. Pre-wired 4-20mA input cables w/ external connector ordered below.
 2. See page 30 for specialty sensors including PTSA, Free Chlorine and CL02.
 3. See page 36 for cell router and service for internet units.....



MegaTron MT Parts

MG-RL-05	Replacement relay card with 5 relays
MG-RL-05-BOX	Complete remote relay box with 5 relays
MG-RL-CPLR	Relay card ribbon cable to wire cable adapter inside controller
MG-RL-CPLR-EXT	Relay card adapter for remote relay box
MG-PWR	Power supply board
MT-DOOR	Clear cover
MG-FUSE-PAK	(5) 2.5 amp fuses
MT-ICM-11	Modbus communications card
MG-CAT5	CAT 5 cable from internal communications card
MG-CROSS	Crossover cable for H1 option
Wi-Fi-MODULE	Wi-fi module for MT and XS-capable units
MT-MAO-4	4-20mA output card with 4 outputs
MT-MAO-8	4-20mA output card with 8 outputs
MT-MAI-4	4-20mA input card with 4 inputs
MT-MAI-8	4-20mA input card with 8 inputs
MT-MAIO-4	4-20 input & output card with 4 inputs and 4 outputs
MT-PSDC24	24 VDC power supply for MT accessories
MT-AUXFLOW-W	10 auxiliary flow meter inputs
AUXFLOW-WIRE	Auxiliary flow meter input cable with 3 pin Molex
MT-SYS-	System card
	Add all of the desired system function codes from the unit model numbering system.
CABLE-7P-2	Prewired 2 conductor cable to mA input and 12VDC power with 7 pin connector, 6'
CABLE-7P-2A	Prewired 2 conductor cable to mA input and no voltage and 7 pin connector, 6'
CABLE-7P-4	Prewired 4 conductor cable to mA input and 12VDC power with 7 pin connector, 6'

MegaTron MT Field Upgrades

MegaTron MT units may be upgraded to add functions and features depending on desired additions and original option configuration. Contact the factory with the model and serial number of the unit and the additions for more details.

Conductivity Control

- C = TE-4A Standard Tower probe 120 PSI (8.2 bar) @ 125°F (51.6°C)
- C0 = Tower Conductivity no probe
- C1 = TE-4ASS Standard Tower probe w/ SS tips 120 PSI (8.2 bar) @ 125°F (51.6°C)
- C3 = AH-4ASS 1" MNPT.....250 PSI (17.2 bar) @ 140°F (60°C)
- C5 = DC-4ASS tank mount 190°F (87.8°C)
- C8 = AL-4RTD pure water, ½" MNPT, RTD temp 100 PSI (6.8 bar) @ 212°F (100°C)
- C10= DI-4A, 1" MNPT 120 PSI (8.2 bar) @ 125°F (51.6°C)
- C11= CS-4ASS corporation stop probe 75 PSI (5.1 bar) @ 140°F (60°C)
- C12= AL-4ASS pure water, ½" MNPT, thermistor 100 PSI (6.8 bar) @ 212°F (100°C)
- B = BE-34BC boiler probe, thermistor, 1" cross.....250 PSI (17.2 bar) @ 400°F (204.4°C)
- B0 = Boiler conductivity no probe
- B1 = BE-4RTDC boiler probe, RTD temp, 1" cross250 PSI (17.2 bar) @ 400°F (204.4°C)
- B2 = BE-32C probe, no temp comp, 1" cross250 PSI (17.2 bar) @ 400°F (204.4°C)
- B6 = BE-4RTD-SC boiler probe, RTD temp, ¾" cross 250 PSI (17.2 bar) @ 400°F (204.4°C)
- B7 = BE-32-SC probe, no temp comp ¾" cross250 PSI (17.2 bar) @ 400°F (204.4°C)
- B9 = Boiler conductivity with RTD temp; no probe
- D = DI-27-4A high conductivity range 120 PSI (8.2 bar) @ 125°F (51.6°C)
- D1 = TE-4A high conductivity range (0-50,000) 120 PSI (8.2 bar) @ 125°F (51.6°C)

Make-up / Miscellaneous Conductivity (max of 1 per controller)

- M = DI-4A Standard Make-up 120 PSI (8.2 bar) @ 125°F (51.6°C)
- M0 = Make-up / miscellaneous conductivity no probe
- M1 = DI-4ASS 120 PSI (8.2 bar) @ 125°F (51.6°C)
- M3 = AH-4ASS 1" MNPT probe250 PSI (17.2 bar) @ 140°F (60°C)
- M4 = TE-4A PVC ¾" slip tee design 120 PSI (8.2 bar) @ 125°F (51.6°C)
- M6 = CS-4ASS corporation stop probe 75 PSI (5.2 bar) @ 140°F (60°C)

pH Control (1 per system max) For dual set point use Q instead of P

- P = TPE-21 Standard Tower 100 PSI (6.8 bar) @ 140°F (60°C)
- P0 = pH Control no probe
- P2 = TPE-21 w/ pre amp 100 PSI (6.8 bar) @ 140°F (60°C)
- P4 = Tank mounted probe (PE-21 with DPE) 140°F (60°C)
- P5 = Tank mount w/ pre amp (PE-21, DPE & RTP-4) 140°F (60°C)
- P8 = PE-21SS stainless steel probe ½" MNPT 200 PSI (13.8 bar) @ 180°F (82.2°C)
- P9 = PE-21SS with pre amp 200 PSI (13.8 bar) @ 180°F (82.2°C)
- P11= PE-11 low ionic probe, ½" MNPT 50 PSI (3.5 bar) @ 180°F (82.2°C)
- P12= PE-11 w/ pre amp 50 PSI (3.4 bar) @ 180°F (82.2°C)
- P15= PE-21CS Corp-stop w/ pre amp, 1" FNPT 100 PSI (6.8 bar) @ 165°F (73.7°C)

ORP Control (1 per controller)

- R = TOE-21 Standard Tower 100 PSI (6.8 bar) @ 140°F (60°C)
- R0 = ORP Control no probe
- R2 = TOE-21 with preamp 100 PSI (6.8 bar) @ 140°F (60°C)
- R4 = Tank mounted probe (OE-21 with DPE) 140°F (60°C)
- R5 = Tank mounted ORP w/ pre amp (OE-21, DPE & RTP-4) 140°F (60°C)
- R8 = OE-21SS stainless steel probe ½" MNPT 200 PSI (13.8 bar) @ 180°F (82.2°C)
- R15= OE-21CS Corp-stop w/ pre amp, 1" FNPT 100 PSI (6.8 bar) @ 180°F (82.2°C)

Feed Timers (max of 5 per controller: 28-DAY, PULSE, %, Recycle, LIMIT or POST BLEED)

F1 to F5 (F4 = Four feed timers)

Flow Switches

- E = Standard float style switch PVC assembly 120 PSI (8.2 bar) @ 125°F (51.6°C)
- E3 = Paddle flow switch PVC assembly 120 PSI (8.2 bar) @ 125°F (51.6°C)
- E4 = Paddle flow switch PVC unassembled, 10' cord 120 PSI (8.2 bar) @ 125°F (51.6°C)
- E5 = Paddle switch brass assem. (order rated probes)..250 PSI (17.2 bar) @ 75°F (23.8°C)
- E6 = Flow switch connection only with cable
- E8 = Standard float switch PVC unassem, 10' cord 120 PSI (8.2 bar) @ 125°F (51.6°C)
- E9 = Paddle flow switch with SS tee only 250 PSI (17.2 bar) @ 75°F (23.8°C)
- E11 = Flow indicator (0-10) with switch, PVC assembly... 100 PSI (6.8 bar) @ 125°F (51.6°C)

After Single System Card features are selected go to the bottom for whole unit options.

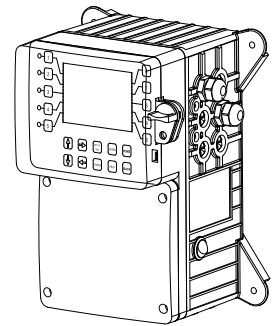

The MegaTronXS comes standard with 5 control relays and digital inputs, 2 water meter inputs and can have communications, 4-20mA and many other options.

For dual boiler units select the features for system 1 followed by a dash then system 2's probe option and E6 option if desired. ie: XSB2F3E6-B2E6-H

MegaTron^{XS} Whole Unit Options

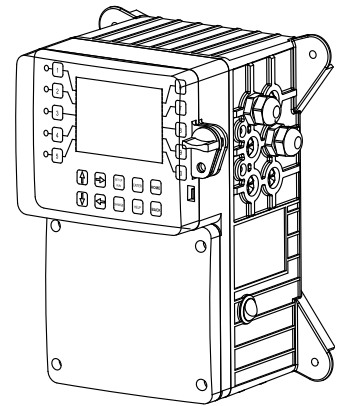

- A = Conduit connections, 120-volt relay cards
- A1 = Liquid tights only with 120-volt relay cards
- A3 = Liquid tights only with CE mark, 240-volt relay cards
- A5 = Prewired power cord to On/Off; 120-volt relay boards have no power
- A6 = Korean power cord, no pigtails, 240-volt relay cards
- A7 = Australian power cord, no pigtails, 240-volt relay cards
- A8 = Prewired USA power cord with 1/2" conduit relay connections; 120-volt
- A9 = Prewired USA power cord; no relay board(s)
- A11 = 240 relay board with USA plugs
- H = Internet card with CAT5 connection and Wi-Fi
- H2 = Internet card with CAT5 connection, no Wi-Fi
- H7 = Internet card with CAT5 connection, Wi-Fi, and zigbee
- H11 = Internet card with CAT5 connection and Modbus TCP/IP
- H21 = Internet card with CAT5 connection and BACnet TCP/IP
- N4 = Four 4-20mA Isolated Inputs
- N8 = Eight 4-20mA isolated inputs (O4 option not available)
- O4 = Four 4-20mA Isolated Outputs
- V = 5 VDC output with water meter connections for paddle wheel flow meters
- V2 = 12 VDC output with water meter connections for paddle wheel flow meters
- W1 = 1 auxiliary flow input for a bleed flow alarm
- W4 = 4 auxiliary flow meter inputs
- Y = ETL Agency Listing
- Z = Black cover instead of clear

- Notes:**
1. Pre-wired 4-20mA input cables w/ external connector ordered below.
 2. See page 28 for specialty sensors including PTSA, Free Chlorine and CL02.
 3. See page 36 for cell router and service for internet units.....



MegaTron^{XS} Parts

MG-RL-05	Replacement relay card with 5 relays
MG-PWR	Power supply board
XS-KEYPAD-ASM	Keypad and display panel assembly (no display)
XS-DISPLAY-ASM	Display panel assembly complete
SS-DOOR	Clear cover
XS-ICM-00	Internet communications card for "H" option
XS-ICM-01	Internet communications card
Wi-Fi-MODULE	Wi-Fi module for MT and XS-capable units
MG-CAT5	CAT 5 cable from internal communications card
XS-MAO-4	4-20mA output card with 4 outputs
XS-MAI-4	4-20mA input card with 4 inputs
XS-MAI-8	4-20mA input card with 8 inputs
XS-MAIO-4	4-20mA card with 4 inputs and 4 outputs
Wi-Fi-MODULE	Wi-Fi module for MT and XS-capable units only
XS-AUXFLOW-W4	4 auxiliary flow meter inputs
XS-USB-ASM	USB board and cable for front panel
AUXFLOW-WIRE	Auxiliary flow meter input cable with 3 pin Molex
XS-SYS-	System card
	Add all desired system function codes from unit model numbering system
CABLE-7P-2	Prewired 2 conductor cable to mA input and 12VDC power with 7 pin connector, 6'
CABLE-7P-2A	Prewired 2 conductor cable to mA input and no voltage and 7 pin connector, 6'
CABLE-7P-4	Prewired 4 conductor cable to mA input and 12VDC power with 7 pin connector, 6'

Note: The prewired input cables simplify connecting to external 4-20mA signal sources that need 12 VDC power on the loop (i.e. fluorometers, level sensors and other specialty probes).

MicroTron Controller

The next generation of MicroTron controllers can control tower or other system functions including: conductivity and a variety of selectable chemical feed timers. Each system control function drives a relay. MicroTrons come with four (4) relay outputs. Choose a base model and add desired options.

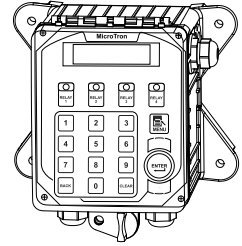

Build a Model

Model **MICRO-** _____ - _____

Tower Conductivity Control & 3 Feed Timers _____

- C = TE-4A Standard Tower probe..... 120 PSI (8.2 bar) @ 125°F (51.6°C)
- C0 = Tower Conductivity no probe
- C1 = TE-4ASS Standard Tower probe w/ SS tips..... 120 PSI (8.2 bar) @ 125°F (51.6°C)
- C3 = AH-4ASS 1" MNPT 250 PSI (17.2 bar) @ 140°F (60°C)
- C5 = DC-4ASS tank mount..... 190°F (87.8°C)

Model **MICRO-F4 -** _____ - _____

Four Selectable Feed Timers (28-DAY, PULSE, RECYCLE or POST TIMER) _____

889.00 F4

Options _____

- A = 100-240 volt conduit connections
- A3 = Liquid tight only with CE mark, 100-240 volt
- A6 = Korean power cord, no pigtails, 240 volt relay card
- A7 = Australian power cord (240 VAC)
- E = Standard float style switch PVC assembly..... 120 PSI (8.2 bar) @ 125°F (51.6°C)
- E3 = Paddle flow switch PVC assembly..... 120 PSI (8.2 bar) @ 125°F (51.6°C)
- E4 = Paddle flow switch PVC unassembled, 10' cord..... 120 PSI (8.2 bar) @ 125°F (51.6°C)
- E5 = Paddle switch brass assembly (order rated probes)..... 250 PSI (17.2 bar) @ 75°F (23.8°C)
- E6 = Flow switch connection only with cable
- E8 = Standard float switch PVC unassembled, 10' cord 120 PSI (8.2 bar) @ 125°F (51.6°C)
- E11 = Flow indicator (0-10) with switch, PVC assembly 100 PSI (6.8 bar) @ 125°F (51.6°C)
- Z = Black cover instead of clear

NanoTron Controller

The NanoTron compact units are designed to automate various applications. Simple step through menu provides user-defined configuration.

Note: All NanoTron units have 2 control relays max, except for corrosion units have 1 powered relay and 1 dry contact relay

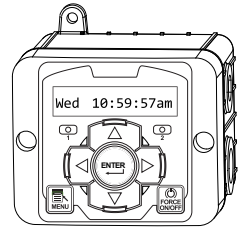

	Model NANO-	_____
Conductivity Control & 1 Feed Timer		
C = TE-4A Standard Tower probe	120 PSI (8.2 bar) @ 125°F (51.6°C)	
C0 = Tower Conductivity no probe		
C1 = TE-4ASS Standard Tower probe w/ SS tips	120 PSI (8.2 bar) @ 125°F (51.6°C)	
C3 = AH-4ASS 1" MNPT	250 PSI (17.2 bar) @ 140°F (60°C)	
C5 = DC-4ASS tank mount	190°F (87.7°C)	
B0 = Boiler conductivity no probe		
B2 = BE-32C probe, no temp comp, 1" cross	250 PSI (17.2 bar) @ 400°F (204.4°C)	
	Model NANO- N -	_____
mA Input & 1 Feed Timer		
N = One mA input & output with 24 VDC		
	Model NANO-	_____
pH or ORP Control & 1 Feed Timer		
P = TPE-21 Standard Tower	100 PSI (6.8 bar) @ 140°F (60°C)	
P0 = pH Control no probe		
P4 = Tank mounted probe (PE-21 with DPE)	140°F (60°C)	
P8 = PE-21SS stainless steel probe ½" MNPT	200 PSI (13.8 bar) @ 180°F (82.2°C)	
P11 = PE-11 low ionic probe, ½" MNPT	50 PSI (3.4 bar) @ 180°F (82.2°C)	
R = TOE-21 Standard Tower	100 PSI (6.8 bar) @ 140°F (60°C)	
R0 = ORP Control no probe		
R4 = Tank mounted probe (OE-21 with DPE)	140°F (60°C)	
R8 = OE-21SS stainless steel probe ½" MNPT	200 PSI (13.8 bar) @ 180°F (82.2°C)	
	Model NANO-F2 -	_____
Two Selectable Feed Timers (28-DAY, PULSE, RECYCLE or POST TIMER)		
F2		
	Model NANO-	_____
Corrosion Monitor with 4-20mA Output of Corrosion & Pitting		
M2 = Corrosion monitor, no sensor body		
M21 = Corr. monitor w/ PVC quick release probe body, ¾" tee	140 PSI (9.7 bar) @ 75°F (23.8°C)	
M22 = Corr. monitor w/ 1" SS threaded probe body	200 PSI (13.8 bar) @ 200°F (93.3°C)	
NOTE: Corrosion sensor tips available at the bottom of page 13.		
Options		
A = 120-volt conduit connections		
A3 = Liquid tights only with CE mark, 240-volt relays		
A5 = USA power cord, no pigtails, 120-volt relays		
A6 = Korean power cord, no pigtails, 240-volt relay card		
A7 = Australian power cord, no pigtails, 240-VAC		
E = Standard float style switch PVC assembly	120 PSI (8.2 bar) @ 125°F (51.6°C)	
E3 = Paddle flow switch PVC assembly	120 PSI (8.2 bar) @ 125°F (51.6°C)	
E4 = Paddle flow switch PVC unassembled, 10' cord	120 PSI (8.2 bar) @ 125°F (51.6°C)	
E5 = Paddle switch brass assembly (order rated probes)	250 PSI (17.2 bar) @ 75°F (23.8°C)	
E6 = Flow switch connection only with cable		
E8 = Standard float switch PVC unassembled, 10' cord	120 PSI (8.2 bar) @ 125°F (51.6°C)	
E11 = Flow indicator (0-10) with switch, PVC assembly	100 PSI (6.8 bar) @ 125°F (51.7°C)	
K = Prewired cable for mA output with external connector (CABLE-7P-2A)		
O1 = One mA output of conductivity on NANO-C/B		
W = Larger enclosure with clear lockable cover		
W1 = Larger enclosure with black lockable cover		
W4 = Larger enclosure with clear lockable cover & 20-amp relay for relay 2		
Y = ETL Agency Listing		

COOLING TOWER ACCESSORIES

Contacting Head Water Meters

Contacting head brass water meters provide an electrical dry contact out for proportional control based on water flow when used with a pulse activated timer or pump.

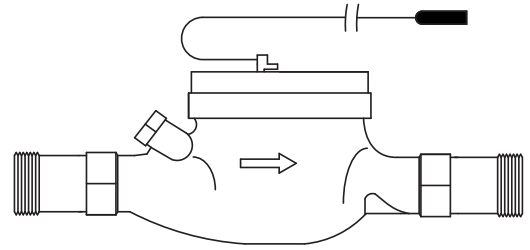

Cold Water Meters 105°F Max

Part Number	Pipe Size	Gallons per Contact	PSI Max	Flow Range GPM	Shipping Wt. (lbs)
AWM-075	3/4"	10	150	0.5-20	4
AWM-100	1"	10	150	1-50	7
AWM-150	1 1/2"	10	150	1.5-100	15
AWM-200	2"	10	150	2-130	17
AWR-2T	2"	100	230	2-400	30
AWR-3T	3"	100	230	3-550	38
AWR-4T	4"	100	230	5-1,250	45

AWM Options	Description
-1	Provides 1 GPC instead of 10 GPC
-100	Provides 100 GPC instead of 10 GPC
-A	Removes reed switch (still contacting head)
-M	Metric (liter) units of measure

Water Meter Accessories

- AW-RS** Reed Switch for meter
- AW-SP2** Signal Splitter 2 Outputs
- AW-SP3** Signal Splitter 3 Outputs
- PD-1** Pulse Divider
- RCT-NANO** Powered remote totalizer (1 or 2 water meters); 120-volts
- AW-2-GASKET** Coupling gaskets for 3/4" meter
- AW-3-GASKET** Coupling gaskets for 1" meter
- AW-4-GASKET** Coupling gaskets for 1.5" meter

Zigbee Wireless Transmitter

ZIG-NANO wirelessly sends up to two water meter or other dry contact switch closures and control two powered or dry contact relay outputs. A remote and base unit is required.

- ZIGB-NANO** Base unit with 2 water meter pulse outputs and 2 dry contact inputs
- ZIGR-NANO** Remote unit with 2 water meter inputs and 2 control relays

Note: The ZIGR-NANO can be used with MegaTron MT or XS models with the Zigbee communications card option.

Bleed-Off Piping Assemblies....Make Maintenance Easy!

Add a strainer and isolation valve to your bleed valve!

A adds poly strainer & brass isolation valve

A1 adds metal y-strainer & brass isolation valve

A4 adds poly y-strainer with flush & brass iso valve

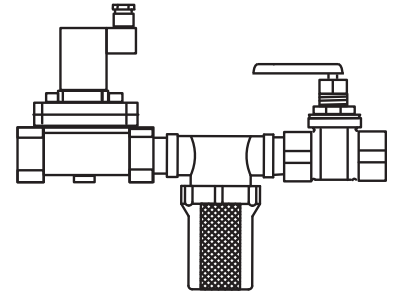

ABC Ball Valves

(Motor open, capacitor return) Max. Temp 140°F

Part	Size	PSI Max
ABC-1/4	1/4".....	225
ABC-1/2	1/2".....	225
ABC-3/4	3/4".....	225
ABC-1	1".....	225

J Conduit junction box attached

J1 Conduit junction box & USA power cord

J2 Conduit junction box with 1/2 FNPT port

S Cover (must have J option)

Brass Motorized Ball Valves

Full Port

(Power open, spring return) Max. Temp 250°F

Part	Size	CV	PSI Max
ABS-1/2	1/2".....	11	130
ABS-3/4	3/4".....	25	130
ABS-1	1".....	50	100
ABS-1 1/2	1-1/2".....	170	70
ABS-2	2".....	250	70

Belimo power open, spring return ball valve Full Port

(Power open, spring return) Max. Temp 212°F

Part	Size	CV	PSI Max
ABV-1/2	1/2".....	10	175
ABV-3/4	3/4".....	14	175
ABV-1	1".....	30	175

W Weather shield for ABS & ABV valves, poly

Brass Motorized Paddle Valves

Max. Temp 250°F

Part	Size	PSI Max
AEC-1/2	1/2".....	50
AEC-3/4	3/4".....	25
AEC-1	1".....	15

ASCO - Brass Solenoid Valves

Max. Temp 125°F

Part	Size	PSI Max
ASCO-1/2	1/2".....	150
ASCO-3/4	3/4".....	150
ASCO-1	1".....	125

Brass Solenoid Valves

Zero PSI Differential

Max. Temp 140°F

Part	Size	PSI Max	CV
SO-1/2	1/2".....	145	4.2
SO-3/4	3/4".....	145	10.5
SO-1	1".....	145	12.9
SO-1 1/2	1-1/2".....	145	35.1

SGO-1/2 1/2".....200.....2.8

SGO-3/4 3/4".....200.....2.8

SGO-1 1".....200.....8.3

GE-SO Solenoid Valves

(Basic solenoid operated) Max. Temp 140°F

Part	Size	PSI Max
GE-SO-1/2	1/2".....	140
GE-SO-3/4	3/4".....	140
GE-SO-1	1".....	140

Valve Options and Parts

P Pre-wired with an 8' cord

C For conduit connections

L UL Listed valves

SGO-1/2-Kit

SGO-3/4-Kit

H-CONN Connector for SO Valves

H-CONN-G Connector for SG Valves

F3 3 GPM PVC flow control

F5 5 GPM PVC flow control

Add -24V for 24 Volt or -230V for 230 Volt

ABS-SHIELD-ASM

ABV-SHIELD-ASM

**SEE ADDITIONAL PLUMBING PARTS
ON PAGES 13, 32 AND 33.**

Corrosion Coupon Racks

Advantage coupon racks are mounted on a polyethylene panel with inlet and outlet ball valves for easy installation. Standard 3/4" & 1" PVC models use our unique quick disconnect coupon holders.

Note: Options selected may reduce pressure ratings.

3/4" PVC Sch 80 120PSI (8.27bar) @ 125°F (51°C)

MODEL
ACR-10
ACR-20
ACR-30
ACR-40
ACR-50
ACR-60

1" PVC Sch 80 120PSI (8.27bar) @ 125°F (51°C)

ACR-11
ACR-21
ACR-31
ACR-41
ACR-51
ACR-61

3/4" 304SS 185PSI (12.7bar) @ 300°F (148°C)

ACR-19
ACR-29
ACR-39
ACR-49
ACR-59
ACR-69

Options

- A Flow control orifice, 3 GPM
- B-2 Flow indicator 6" long, 1-10 GPM 145 PSI @ 212°F max (not recommended on PVC racks)
- B-7 Flow indicator 7.5" long, 1-10 GPM 100 PSI @ 125°F max
- C Flow control orifice, 5 GPM
- E Sample tee with valve
- F Back flow check valve
- G Basket strainer (120 PSI @ 80°F max)
- H Steel Y-strainer
- H1 Poly Y-strainer with flush valve (YP-3/4-SP)
- J Provide clear PVC piping over coupon
- K Omit 3/4" ball Valves
- K-1 Omit 1" ball Valves
- K2 PVC true union isolation valves (3/4")
- K3 PVC true union isolation valves (1")
- K4 Brass isolation valves on PVC racks
- K5 3/4" SS isolation valves on PVC racks
- L 3/4" FNPT for use with corrosion probes. Includes pipe plug for 3/4" & 1" PVC racks only
- L1 3/4" PVC quick release corrosion tee - for 3/4" & 1" PVC racks only
- L2 1" FNPT tee for high temp corrosion sensor
- M Mounting rails (add to poly panel)
- M1 Mounting rails (instead of poly panel)
- N 1/2" blue poly
- R22 (2) 3/4" SS injection tees
- R3 3 PVC quick release probe tees 3/4" - for 3/4" PVC racks only
- S 3/4" removable section of black iron pipe, 6" long
- S1 1" removable section of black iron pipe, 6" long
- S2 3/4" removable section of SS pipe, 6" long
- T Extends metal racks mounting brackets by 3/4"
- U No poly panel partially assembled with mounting brackets

3/4" Black Iron 185PSI (12.7bar) @ 300°F (148°C)

ACR-15
ACR-25
ACR-35
ACR-45
ACR-55
ACR-65

1" Black Iron 185PSI (12.7bar) @ 300°F (148°C)

ACR-18
ACR-28
ACR-38
ACR-48
ACR-58
ACR-68

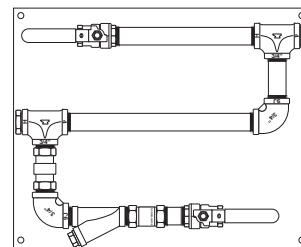
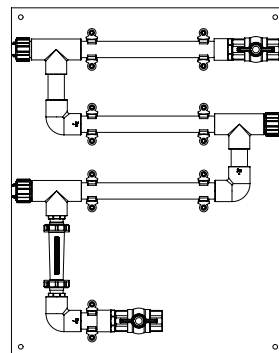

Coupon Rack Parts

ACR-CH	Complete 3/4" PVC holder and quick release tee
ACR-CH-1	1" male slip PVC quick release holder (no tee)
ACR-CH-1-T	Complete 1" slip PVC quick release holder and tee
ACR-CH1/2	1/2" PVC Coupon Holder
ACR-CHB	Black Iron Coupon Holder 3/4"..
ACR-CH-QH	Complete 3/4" PVC Holder; no tee
ACR-NHW	Nylon Hardware
ACR-CHSS	Coupon Holder 3/4" MNPT, 304 Stainless Steel
BV-3/4	PVC Ball Valve for ACR
BV-1-PVC	1" PVC ball valve for ACR
CKV-3/4PP	Backcheck, 3/4" FNPT, poly
CKV-3/4SS	Backcheck, 3/4" FNPT, stainless steel
CLAMP-3/4	3/4" pipe clamp (includes both sides)
E-30-PH	"O" Ring Seal for Holder
FLOW-75-10A	Flow Indicator, 3/4" MNPT, 7.5" long, 100 PSI and 125°F
FLOW-3/4	Flow Indicator, 3/4" MNPT, 9.5" long
FLOW-3/4-BR	Flow Indicator, 3/4" MNPT, 9.5" long with brass fittings
FLOW-2HT	Flow Indicator, 3/4" MNPT, 145 PSI and 212°F max
FLOW-75-10AFS	Flow Indicator, 3/4" MNPT, 7.5" long, 100 PSI and 125°F max with flow switch
FLOW-75-SWITCH	Switch for FLOW-75-10AFS
F-4411V	O-ring for all flow indicators except FLOW-2HT
OR3-BE	Flow Restrictor - 3 GPM, Brass
OR3-BE-P	Flow Restrictor - 3 GPM, PVC
OR5-BE	Flow Restrictor - 5 GPM, Brass
OR5-BE-P	Flow Restrictor - 5 GPM, PVC
OR8-BE	Flow Restrictor - 8 GPM, Brass
OR8-BE-P	Flow Restrictor - 8 GPM, PVC
OR10-BE	Flow Restrictor - 10 GPM, Brass
T-C	Coupon Holder T only
T-ADAPT	Quick disconnect coupon opening to 1" slip adaptor
SPOOL-075-M	Removable mild steel pipe, 3/4"x12" plus unions
SPOOL-075-P	Removable PVC pipe, 3/4"x12" plus unions

Corrosion Rack & Monitor Parts

Coupons

AMS	Mild Steel
ACO	Copper
AS4	304 Stainless Steel
AS5	316 Stainless Steel
ANK	Nickel
ABR	Brass
ABA	Aluminum
AGS	Galvanized Steel

Scale Coupon

ASC-5	316 Stainless Steel
-------	---------------------

Note: Additional coupon materials and styles available. Consult factory for details.

Corrosion Tips

CE-MS	Pair of Mild Steel
CE-CO	Pair of Copper
CE-BR	Pair of Brass (Admiralty)
CE-CN	Pair of Cupro-Nickel
CE-AL	Pair of Aluminum
CE-SS-304L	Pair of 304SS
CE-SS-316L	Pair of 316SS
COR-TEST-MS5	Corrosion test plug (5 ml/yr)

Corrosion Sensor Body

CE-BODY-1	PVC 3/4" quick release tee
CE-BODY-2	1" MNPT SS and CPVC
CE-BODY-3	3/4" MNPT CPVC

Corrosion Loop Guard

CLG units provide a professional approach to corrosion monitoring and control. Combined with separately-ordered, real-time NANO-M corrosion monitors and/or other feed equipment for automated feed of closed loop treatment. All models included isolation and sample valves mounted on white poly.

Select loop material based on required temperature and pressure rating.
 PVC has a max rating of 120 PSI (8.2 bar) @ 125° F (51.67°C).
 Iron and SS have a max of 185 PSI (12.7 bar) @ 300°F (148.9°C).
 Options selected will lower max ratings.

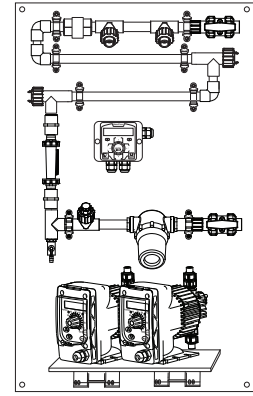

Model **CLG** - _____

Loop Material and # of Coupons					
	3/4" PVC	1" PVC	3/4" Iron	1" Iron	1" SS
2 holders....	A2	A12	A22	A32	A52
3 holders....	A3	A13	A23	A33	A53
4 holders....	A4	A14	A24	A34	A54
5 holders....	A5	A15	A25	A35	A55
Corrosion Sensor Ports					
B = (2) quick release 3/4" PVC			B4 = (2) 1" FNPT ports in 1" iron		
B1 = (2) quick release 1" PVC			B5 = (2) 1" FNPT port in 1" SS tee		
B2 = (2) 1" FNPT ports in 1" tee					
Controller Space & Mounting Hardware (order controller and/or pumps separately)					
C0 = No controller space			C3 = Room for 3 NanoTrons		
C1 = Room for 1 NanoTron			C4 = Room for 1 MegaTron XS		
C2 = Room for 2 NanoTrons					
Sensor Tees					
D = (1) 3/4" PVC quick release			D5 = (1) 1" SS tee		
D2 = (2) 3/4" PVC quick releases			D6 = (2) 1" SS tees		
D3 = (1) 1" Iron tee			D7 = (2) 3/4" PVC quick release, (1) flow tee		
D4 = (2) 1" Iron tees					
Strainer Options					
E = 3/4" basket			E4 = 10" poly filter cold (3/4")		
E1 = 3/4" flushable y			E5 = 10" poly filter hot (3/4")		
E2 = 1" basket			E6 = 3/4" SS strainer		
E3 = 3/4" Black iron			120 PSI @160°F		
Flow Indicator 1-10 GPM					
F = 3/4" 100 PSI @ 125°F			F2 = 3/4" 145 PSI @ 212°F		
F3 = 3/4" w/ flow switch					
Flow Restrictor 1-10 GPM					
G = 3/4" PVC 3 GPM			G3 = 3/4" Brass 3 GPM		
G1 = 3/4" PVC 5 GPM			G4 = 3/4" Brass 5 GPM		
Loop Direction: Standard is in and out on the right.					
K = In/Out left		K1 = Left to Right		K4 = Right to Left	
Injection					
N1 = 1 tee	N11	3/4" Black Iron	N21	1" Iron	N31
N2 = 2 tees	N12	N22	N32	3/4" SS	N41
					N42

Options	
L = Clear pipe over holders on PVC 120 PSI (8.2 bar) @ 80° (26.6°C)	R = Mounting rails
P = 2 pump shelf	S = Electrical junction box
P1 = 2 pump shelf w/ SS brackets	U = 1/2" blue poly panel
Q = Poly back check	W = Free standing legs
Q1 = 3/4" SS back check	

Solid Feed Systems

SFS solid feed systems include a dissolving bowl with a 0.6 GPM at 10 PSI spray nozzle; shut-off valves on inlet water and pump suction connection, pressure regulator, solenoid, Y-strainer and level switches (most models).

120-volt units have a test switch, LED for power and control with a lockable cover.

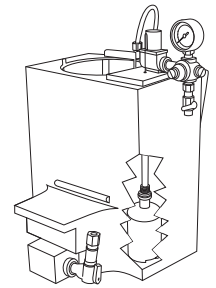

SFS-G01	Single dissolving bowl in a tank with non-electric make-up valve
SFS-G02	Dual dissolving bowls in a tank with non-electric make-up valve
SFS-G10	Single dissolving bowl in a large tank with non-electric make-up valve
SFS-101	Single dissolving bowl in a tank with 12 VDC controller
SFS-105	Single dissolving bowl and tank with 120 VAC controller on panel
SFS-10	Dissolving bowl with 120-volt solenoid, pressure regulator, no tank or controller
SFS-20	Two dissolving bowls with one 120-volt solenoid, regulator, no tank or controller
SFS-T01	Dissolving bowl with battery powered timer valve, regulator and gauge on panel
SFS-DF1	Tank and bowl (no plumbing) for liquid concentration

Options

A	Conduit connections
A2	240 volt with conduit connections (not available on 101's)
A3	240/120 wall adapter for SFS-101 with international plugs
B1	Back check in pump suction line
D	1" FNPT port on the top of the tank for conductivity probe
D2	Adjustable level wand for external monitoring
D3	½" Liquid tight in bowl with SFS-E4A conductivity probe
E	10' of ¾" I.D. clear tubing for overflow
G	Blue back panel for 105
H	High Level Alarm Cut-off with LED and Alarm Relay Output on 120-volt models
H2	Adds a high-level cut-off to SFS-101 controller
H3	High alarm with cut-off and second brass solenoid N.O. on 120-volt units
J	Low pressure spray nozzle (30-45 PSI)
K	Gray dissolving tank
L	Provide 120-volt level controller for remote mounting with SFS-101
P	Non Advantage Controls metering pump mounting adaptor
V	Viton seats in electric solenoid valve
W	Adjustable wands
Y	Partial PVC piping instead of brass on G01 & G02

APTech Ultra-M

SFS-ULTRA-M Single dissolving system with non-electric float

Mounting Panels for SFS Feeders

SFS-PANEL-2	½" blue poly panel for 2 SFS-G01, or 101 (34" x 24")
SFS-PANEL-3	½" blue poly panel for 3 SFS-G01, or 101 (46" x 24")
SFS-PANEL-31	½" blue poly panel for 1 SFS-G02 and 2 SFS-G01 or 101
SFS-PANEL-32	½" blue poly panel for 3 SFS-G02 (60" x 24")
SFS-PANEL-41	½" blue poly panel for 3 SFS-G01 & G02 (72" x 24")

Options for SFS-PANEL

A	¾" PVC freshwater header with shut-off
D	¾" PVC overflow to drain header
W	Free standing leg kit

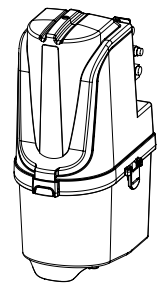

Solid Feed Systems - *continued*

Parts

R00223	SS Wall Mounting Bracket
SFS-BV	Brass Inlet Valve
SFS-C01	12-volt controller for 101 and 201 models
SFS-C?05	120-volt controller for ?05 models, list 105, 205, 305 to match
SFS-C05-H	120-volt controller for 05 models with option H
SFS-CV-1/4	1/4" brass check valve
SFS-DB-1	Dissolving Bowl (Advantage PVC bowl assembly)
SFS-DB-1D3	Dissolving bowl with 1/2" liquid tight for SFS-E4A probe
SFS-DB-ARM-1	Spray arm for dissolving bowl (Advantage PVC spray arm assembly)
SFS-DB-DF1	Dissolving bowl with piercing stem for concentrates
SFS-E4A	Special conductivity probe for SFS-G01(02) models
SFS-FLOAT	Non-electric float bottle
SFS-FV-G01	Non-electric fill valve for G01, no float
SFS-FV-G02	Non-electric fill valve for G02, no float
SFS-LF	Individual float switch for electric float switches
SFS-LF-1	1 Level Float Assembly
SFS-LF-2	2 Level Float Assembly
SFS-LF-2-FH01	Level wands for SFS-FH01
SFS-LF-3	3 Level Float Assembly
SFS-LF-G01	Level float and inlet valve assembly for SFS-G01 (no gauge, regulator, or strainer)
SFS-LF-G02	Level float and inlet valve assembly for SFS-G02 (no gauge, regulator, or strainer)
SFS-NHW	Set of 4 nylon bolts & washers for valve panel on G01 & G02
SFS-PA-101M	Plumbing assembly for 101M (solenoid, inlet valve, pressure regulator & gauge)
SFS-PA-105M	Plumbing assembly for 105M (solenoid, inlet valve, pressure regulator & gauge)
SFS-PA-G01	Plumbing assembly for G01 (inlet, y-strainer, pressure regulator & gauge)
SFS-PA-G01-Y	Plumbing assembly with Y options
SFS-PA-G02	Plumbing assembly for G02 (inlet, y-strainer, pressure regulator & gauge)
SFS-PG	Pressure Gauge
SFS-PG-Y	ABS body pressure gauge
SFS-PR	Pressure Regulator
SFS-SB-12V	Brass solenoid valve with y-strainer 12-volt D.C.
SFS-SB-120V	Brass solenoid valve with y-strainer 120-volt A.C.
SFS-SB-KIT	Repair kit for 12V or 120V solenoid valves
SFS-SUCTION	Outlet pump suction assembly
SFS-SUCTION-25	Outlet pump suction assembly with 1/4" tubing connection
SFS-SUCTION-SS	3/8" tubing connection with SS ball valve
SFS-TANK-101	Replacement tank for the SFS-101
SFS-TANK-205	Tank only for 205
SFS-TANK-G01	Replacement tank for the SFS-G01
SFS-TANK-G02	Replacement tank for the SFS-G02
SFS-TIP-LP	Low pressure spray tip
SFS-WT	Wall transformer for 12-volt D.C. models
SFS-Y	Y-strainer on SFS plumbing
1A2A000122	Pump mounting t-nut for G01, 101 tanks
1P1P000228	1/4" FNPT x 3/8" tubing
1P1P000229	1/4" NPT to 1/4" tubing connector
1S1F000001	Overflow tubing
2C4A000012F	1/4" MNPT to 1/4" push lock tubing
2C4A000030	1/4" NPT to 1/4" tubing elbow
2C4A000051	1/2" MNPT to 1/4" FNPT reducer for pump suction on tank
2C4A000056	Overflow elbow
2C4A000059	Replacement spray nozzle
2C4A000060	1/2" tubing x 1/4" MNPT connector
2C4A000087	Replacement panel for SFS-G01 valve holder
2C4A000090	1/4" MNPT x garden hose female (for use with SFS-T01)

Prefabricated Systems

Wall Mounts

Full size wall mounts for a controller, 1-4 plumbing loops, pumps and accessories make a professional installation easy and saves you time and money.

Build one to your specs on page 18. Start with WM and code for number of plumbing loops and panel material desired, "WM2". Then select options A-J for each loop. If additional loops are the same, use a -X2, X3 or X4. After all loops are built, list whole unit options: WM2-AB3D3FJ-X2.

- NOTE:**
1. Multi-loop panels come in sections.
 2. Option "H" on wall mount units are not available on multi-loop panels.

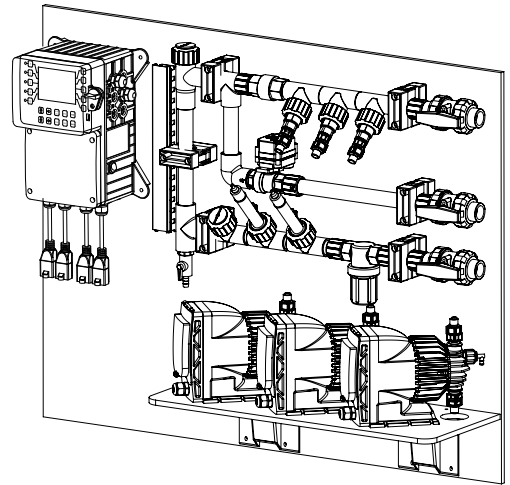

Controller Mount Boards

Controller mount boards are a low-cost option making installation fast and easy on compact poly boards for controller and sample stream assemblies.

Build one to your specs on page 19.

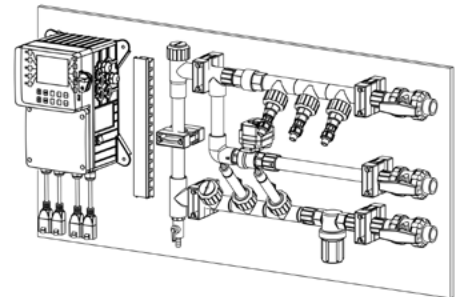

Fully Enclosed Cabinets

The FE series of fully enclosed pre-fabs provide a safe and secure professional installation that saves time and money while protecting your water treatment equipment from the elements and tampering.

Build one to your specs on page 20.

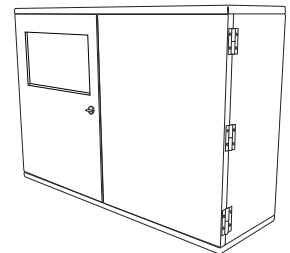

All Prefabs Please Note:

- Controller, pumps, and bleed valves are ordered separately. Panel dimensions may vary depending upon options and controller selections.
- If ordering option "C" for probes, a 3/4" PVC 90° flow tee is automatically included on 3/4" & 1" PVC loops. If a 1" PVC straight flow tee is needed, add a 1 to start the # sequence (i.e. C12 for 1" flow tee and two 3/4" probe tees). If no 3/4" PVC 90° flow tee is desired, add a 0 to start the # sequence (i.e. C02).

Note: The option "C" should only be used if the number of probe tees desired is different than what the controller on the order comes with or if no controller is on the order. The option "C" used will reflect the total number of tees included (i.e. C3 will provide three probe tees on the prefab not counting the flow switch tee).

Additional pump shelf brackets options on WM, CM, and FE models.

If SS brackets are desired for poly pump shelf, use the following codes and additional pricing:

DD1	1 pump
DD2	2 pumps
DD3	3 pumps
DD4	4 pumps
DD5	5 pumps

NOTE: If Pulsatron Series A+, C+, C mounting pattern is needed, add a "2" to the end of the "D" selection.

Wall Mounts

Model WM _____ - _____ - _____

Number of Plumbing Loops on $\frac{3}{8}$ " White Poly Panel (add to base) _____
1, 2, 3, or 4

Number of Plumbing Loops on $\frac{1}{2}$ " Blue Panel (add to base)
21, 22, 23, 24

Loop Material With valves, strainer, back check and sample (*no strainer & check) _____

A = $\frac{3}{4}$ " PVC **A0** = no loop **A1** = 1" PVC
A2 = $\frac{3}{4}$ " Black iron **A3** = $\frac{3}{4}$ " Copper **A4** = 1" Black iron
A6 = $\frac{3}{4}$ " brass valves on PVC loop **A7** = $\frac{3}{4}$ " SS valves on PVC loop

Injection	$\frac{3}{4}$" PVC	1" PVC	1" CPVC	$\frac{3}{4}$" Black Iron	1" Iron
	B1 = 1 tee	B11	B21	B31	B41
	B2 = 2 tees	B12	B22	B32	B42
	B3 = 3 tees	B13	B23	B33	B43
	B4 = 4 tees	B14	B24	B34	B44

Probe Tees (only if different than controller ordered, reflects total number of tees - see page 17) _____

$\frac{3}{4}$" PVC Quick Release	1" PVC Quick Release	1" Black Iron
C1 = 1 tee	C21	C41
C2 = 2 tees	C22	C42
C3 = 3 tees	C23	C43

Pump Mounting Shelf (add a "1" after number for blank shelf) _____

D1 = Shelf for 1	D2 = Shelf for 2	D3 = Shelf for 3
D4 = Shelf for 4	D5 = Shelf for 5	D6 = Shelf for 6

Strainer Options ($\frac{3}{4}$ " basket strainer included as standard) _____

E = $\frac{3}{4}$ " flushable	E2 = $\frac{3}{4}$ " 10" filter housing	E4 = 1" basket strainer
E5 = $\frac{3}{4}$ " Black Iron Strainer	E6 = 1" Clear basket	

Flow Indicator 1-10 GPM _____

F = $\frac{3}{4}$ " 100 PSI	F2 = $\frac{3}{4}$ " 145 PSI
F3 = $\frac{3}{4}$ " 100 PSI with flow switch	

Coupons	$\frac{3}{4}$" PVC	1" PVC	$\frac{3}{4}$" Black Iron
	G2 = 2 Stations	G12 = 2 Stations	G22 = 2 Stations
	G4 = 4 Stations	G14 = 4 Stations	G24 = 4 Stations

Add "L" to get clear PVC over coupon.

Solid Feeder (order SFS separately / D1 or D2 available with H1 / no D option with H2) _____

H1 = For a SFS-?01	H2 = For 2 SFS-?01's	H3 = For 3 SFS-?01's
---------------------------	-----------------------------	-----------------------------

J = Bleed off leg with shut-off valve (order bleed valve separate)

J1 = Bleed off leg with shut-off valve & $\frac{3}{4}$ " water meter (order bleed valve separate)

Loop Direction: Standard is in/out Right; dual is (1) In/Out Right and (1) In/Out Left _____

K = In/Out Left	K1 = Left to Right	K2 = In/Out Bottom	K3 = In/Out Top	K4 = Right to Left
------------------------	---------------------------	---------------------------	------------------------	---------------------------

Corrosion Sensor Tees 90° _____

M1 = 1 PVC $\frac{3}{4}$ "	M11 = 1 PVC 1"	M21 = 1 Iron 1"
M2 = 2 PVC $\frac{3}{4}$ "	M12 = 2 PVC 1"	M22 = 2 Iron 1"

Controller Mount Area (only needed if ordered without a controller) _____

N = MegaTron XS	N1 = MegaTron MT	N4 = Micro / Nano-W	N5 = NanoTron	N6 = R pump
------------------------	-------------------------	----------------------------	----------------------	--------------------

Whole Pre-Fab Options _____

R = Mounting rails (required w/ H's)
T = Weather shield 37" wide max
Y = Non ACI equip to be supplied

S = Electrical junction box
W = Free standing leg kit
X = Circulation pump (4 GPM)

Controller Mount Boards

Model **CM** _____ - - - - -

Board Dimensions and Loop Options

- 00** = Partially assembled plumbing only, no panel
- 05** = 24" wide x 20" tall board for single loop only, no controller mount area
- 10** = 34" wide x 20" tall board for single controller and loop

Note: Panel sizes vary depending on options

Loop Material With isolation valve and sample port

- | | | |
|--|---|--------------------|
| A = 3/4" PVC | A0 = no loop | A1 = 1" PVC |
| A4 = 1" Black iron | A6 = 3/4" brass valves on PVC loop | |
| A7 = 3/4" SS valves on PVC loop | A9 = 3/4" SS loop | |

Injection Tees

- | 3/4" PVC | 1" PVC | 1" CPVC | 1" Iron | 3/4" SS |
|--------------------|------------|------------|------------|------------|
| B1 = 1 tee | B11 | B21 | B41 | B51 |
| B2 = 2 tees | B12 | B22 | B42 | B52 |
| B3 = 3 tees | B13 | B23 | B43 | B53 |
| B4 = 4 tees | B14 | B24 | B44 | B54 |

Probe Tees (only if different than controller ordered, reflects total number of tees - see page 17)

- | 3/4" PVC Quick Release | 1" PVC Quick Release | 1" Black Iron | 1" SS |
|------------------------|----------------------|---------------|------------|
| C1 = 1 tee | C21 | C41 | C51 |
| C2 = 2 tees | C22 | C42 | C52 |
| C3 = 3 tees | C23 | C43 | C53 |

Pump Mounting Shelf (shelf adds 16" to height; add a "1" after number for blank shelf)

- | | | |
|--------------------|--------------------|--------------------|
| D2 = 2 pump | D3 = 3 pump | D4 = 4 pump |
|--------------------|--------------------|--------------------|

Strainer Options (Not included as standard)

- | | | |
|--------------------------------|------------------------------|--------------------------------|
| E = 3/4" Basket | E1 = 3/4" Flushable Y | E2 = 10" Filter Housing |
| E4 = 1" Basket Strainer | E6 = 1" Clear Basket | E7 = 3/4" SS Strainer |

Flow Indicator 1-10 GPM

- | | |
|--|-------------------------|
| F = 3/4" 100PSI | F2 = 3/4" 145PSI |
| F3 = 3/4" 100PSI with flow switch | |

Coupons

- | 3/4" PVC | 1" PVC | 3/4" Black Iron |
|------------------------|-------------------------|-------------------------|
| G2 = 2 Stations | G12 = 2 Stations | G22 = 2 Stations |
| G4 = 4 Stations | G14 = 4 Stations | G24 = 4 Stations |

Add "L" to get clear PVC over coupon.
Coupon stations increase panel height.

- J** = Bleed off leg with shut-off valve (order bleed valve separate)
- J9** = 304 SS bleed off leg with shut-off valve (order bleed valve separate)

Loop Direction: Standard is water in and out on the right.

- | | | | | |
|------------------------|---------------------------|---------------------------|------------------------|---------------------------|
| K = In/Out Left | K1 = Left to Right | K2 = In/Out Bottom | K3 = In/Out Top | K4 = Right to Left |
|------------------------|---------------------------|---------------------------|------------------------|---------------------------|

Corrosion Sensor Tees 90°

- | | | |
|------------------------|-----------------------|------------------------|
| M1 = 1 PVC 3/4" | M11 = 1 PVC 1" | M21 = 1 Iron 1" |
| M2 = 2 PVC 3/4" | M12 = 2 PVC 1" | M22 = 2 Iron 1" |

Controller Mount Area (only needed if ordered without a controller)

- | | | | | |
|------------------------|-------------------------|----------------------------|----------------------|--------------------|
| N = MegaTron XS | N1 = MegaTron MT | N4 = Micro / Nano-W | N5 = NanoTron | N6 = R Pump |
|------------------------|-------------------------|----------------------------|----------------------|--------------------|

- | | |
|----------------------------------|-------------------------------|
| Q = Backcheck (3/4" POLY) | Q1 = 3/4" SS Backcheck |
|----------------------------------|-------------------------------|

Whole Pre-Fab Options

- | | |
|---|--|
| S = Electrical junction box | R = Mounting rails |
| U = 1/2" Blue poly panel | T = Weather shield (37" wide max) |
| Y = Non ACI equip to be supplied | X = Circulation pump (4 GPM) |

Fully Enclosed Cabinets

Model FE _____ - _____ - _____

Enclosure Type _____

3 = Metal 48"W x 36"H x 16"D with key lock double doors

Loop Material with valves, strainer, back check and sample (*no strainer & check) _____

A = 3/4" PVC	A0 = no loop	A1 = 1" PVC
A2 = 3/4" Black iron	A3 = 3/4" Copper	A4 = 1" Black iron
A6 = 3/4" brass valves on PVC loop	A7 = 3/4" SS valves on PVC loop	

Injection 3/4" PVC	1" PVC	1" CPVC	3/4" Black Iron
B1 = 1 tee	B11	B21	B31
B2 = 2 tees	B12	B22	B32
B3 = 3 tees	B13	B23	B33
B4 = 4 tees	B14	B24	B34

Probe Tees (only if different than controller ordered, reflects total number of tees - see page 17) _____

3/4" PVC Quick Release	1" PVC Quick Release	1" Black Iron
C1 = 1 tee	C21	C41
C2 = 2 tees	C22	C42
C3 = 3 tees	C23	C43

Pump Mounting Shelf (add a "1" after number for blank shelf) _____

D1 = 1 pump	D2 = 2 pump	D3 = 3 pump	D4 = 4 pump
--------------------	--------------------	--------------------	--------------------

Strainer Options (3/4" basket strainer included as standard) _____

E = 3/4" flushable	E4 = 1" Basket Strainer	E6 = 1" Clear Basket
---------------------------	--------------------------------	-----------------------------

Flow Indicator 1-10 GPM _____

F = 3/4" 100 PSI	F2 = 3/4" 145 PSI
F3 = 3/4" 100 PSI with flow switch	

Corrosion Coupon Stations (must be standard or K loop direction) _____

3/4" PVC	1" PVC	3/4" Black Iron
G2 = 2 Stations	G12 = 2 Stations	G22 = 2 Stations
Add "L" to get clear PVC over coupon		

Solid Feeder (order SFS separately; no D or G options with H; no room for controller with H3) _____

H1 = For a SFS-101	H2 = For 2 SFS-101's	H3 = For 3 SFS-101's
---------------------------	-----------------------------	-----------------------------

J = Bleed off leg with shut-off valve (order bleed valve separately)

Loop Direction: Standard is in and out on the right. _____

K = In/Out Left	K1 = Left to Right	K2 = In/Out Bottom	K3 = In/Out Top	K4 = Right to Left
------------------------	---------------------------	---------------------------	------------------------	---------------------------

Corrosion Sensor Tees 90° _____

M1 = 1 PVC 3/4"	M11 = 1 PVC 1"	M21 = 1 Iron 1"
M2 = 2 PVC 3/4"	M12 = 2 PVC 1"	M22 = 2 Iron 1"

Controller Mount Area (only needed if ordered without a controller) _____

N = MegaTron XS	N1 = MegaTron MT	N4 = Micro / Nano-W	N5 = NanoTron
------------------------	-------------------------	----------------------------	----------------------

Whole Pre-Fab Options _____

R = Mounting rails	V1 =Window(right door)
S = Electrical junction box	W = Free standing leg kit
S1 =Electrical box with light kit	X = Circulation pump (4 GPM)
U = Strainer external mount kit	Y = Non ACI equipment to be supplied
V = Window(left door)	

EVC Systems

Model **EVC** - _____

Controller Selection _____

- 1 = Nano-C control with 1 timer
- 3 = Micro-C control with 3 timers

Board Selection _____

- X - No board
- A - EVC on blue panel with no pump shelf
- B - EVC on blue panel with 1 pump shelf; 33"x 18"
- C - EVC on blue panel with 3 pump shelf; 42"x 24"

Pump Selection (Individually boxed) _____

- X - No pumps
- 1 - One 15 GPD pump
- 2 - One 30 GPD pump
- 3 - Three 15 GPD pumps
- 4 - Three 30 GPD pumps

Water Meter Selection (Individually boxed) _____

- X - No water meter
- A - 3/4" water meter
- B - 1" water meter

Options _____

- A = 120VAC conduit
- A3= 220VAC liquid tights
- B = Black cover on EVC
- S = 3/4" PVC sample tee & valve (loose with no board)
- K1= In left out right plumbing
- K2= Removes isolation valve and adds return tee for continuous sampling

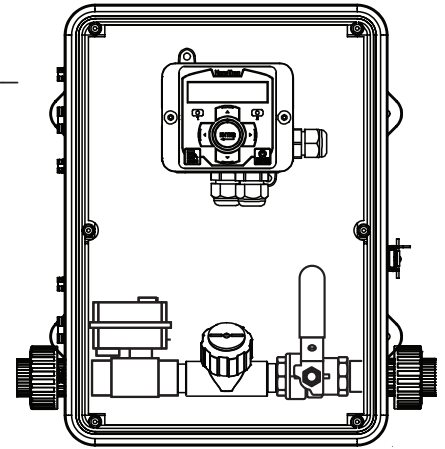

Multi-Box

Multiple use NEMA 4X style plastic enclosure with a clear hinged lid, lockable stainless steel latch, liquid tights knock-outs and external mounting feet. Can be mounted vertically or horizontally. Ideal for mounting SS or XS controllers or metering pumps for added protection and safety.

Outer Dimensions: 16.5" H x 13.5" W x 8.75" D Inner Dimensions: 14.25" H x 10" W x 7.5" D

MULTI-BOX Plastic enclosure with clear lid

Options

- B Black cover
- G Grommet package
- P Back panel, 1/2" blue poly inside box for mounting items
- X Mount separately ordered controller or pump in box

Small Mounting Panels (No plumbing)

- SS-CMB** = Mounting panel for XS controllers
- SS-CMB-U** = Mounting panel for XS controllers, blue
- MG-CMB** = Mounting panel for MG controllers
- NANO-CMB** = Mounting panel for Nano controllers

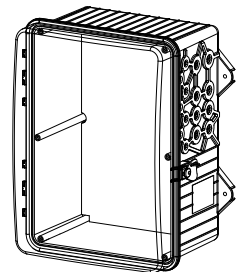

Glycol Feeder for Closed Loop Systems

Model **GF** - _____

Tank Selection _____

- 1 = 55 GAL (208L) poly
- 2 = 100 GAL (378L) poly
- 3 = 30 GAL (113L) poly
- 4 = 50 GAL (189L) carbon steel
- 7 = 150 GAL (567L) poly

Stand Selection _____

- A = Powder coated steel stand
- B = Powder coated steel stand + mixer bracket
- C = Tank top mount (no tank or stand)
- D = Portable stand with built in rollers

Pump Selection _____

*Dual pump sys. require 2 pump selections (i.e. -11)

- 0 = No pump
- 1 = 1.5 GPM at 100 PSI; 1/3 HP
- 2 = 3.3 GPM at 100 PSI; 1/2 HP
- 3 = 6.1 GPM at 60 PSI; 3/4 HP
- 4 = 9.9 GPM at 60 PSI; 1.5 HP

Pump Configuration _____

- A = Standard configuration
- B = Alternating pumps for single loops (requires 2 pump selections)
- C = Pump plumbed for transfer duty into tank

Loop Selection _____

*Dual loop sys. require 2 loop selections (i.e. -11)

- 0 = No loop
- 1 = Sch 80 PVC loop; 100 PSI max; 100°F max
- 2 = Copper/brass loop; 100 PSI max; 180°F max
- 3 = Carbon steel loop; 100 PSI max

Control Selection _____

- M = NANO w/ alarm buzzer & contact, ETL, 0-100 PSI sensor, single loop
- G = XS controller w/ ETL listing, pressure sensor for single loop
- H = XS controller w/ ETL listing, pressure sensors for dual loop
- D = Pressure transducer, level wand and pump starter relay for use with separately ordered MegaTron with 4-20mA input ability (per loop)
- E = Manual pump control; no pressure switch or level wand

Options _____

- 1 = 240V (only available with pump option 0 or 2)
- 5 = Position back check to use tank for expansion
- C1 = Communications card Internet (XS controller only)
- C11 = Communications card w/ Modbus TCP/IP
- C12 = Communications card w/ Bacnet TCP/IP (read only)
- C22 = Communications card w/ Bacnet (read/write)
- H = 0-200 PSI pressure transducer and gauge (per loop)
- M = Mixer controls (order mixer separate)
- O4 = Four 4-20mA outputs (XS controller only)
- S = ON/OFF switch (included on control options G & H)

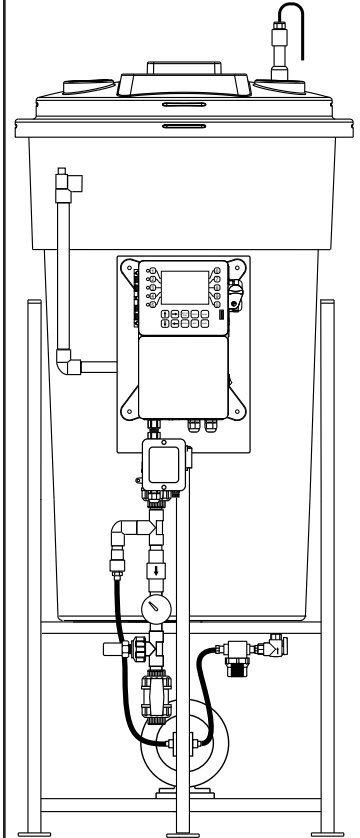

Glycol Feeder Parts

1A2A000011	Fuse 12A 250V slow blow ceramic (for glycol feeders)
991F41	1.5 GPM Pump at 100 PSI; 1/3 HP Motor
992MJ07	3.3 GPM Pump at 100 PSI; 1/2 HP Motor
AGF-APCT-55	Replacement 55-gallon tank for glycol feeder
AGF-ATS-5	Replacement 5-gallon tank for glycol feeder
AGF-BLS	Bowl strainer for suction side of pump
AGF-LPS	Mechanical pressure switch (8-23 PSI)
AGF-PG	Pressure gauge 0-100
AGF-PG-200	Pressure gauge 0-200
AGF-PRV	Pressure relief valve (brass)
AGF-PS	Mechanical pressure switch (30-50 PSI)
AGF-PTD	Pressure transducer for (2 wire 4-20 mA 0-100 PSI)
AGF-PTD-200	Pressure transducer (2 wire 4-20 mA 0-200 PSI)
AGF-SUCTION	Pump suction assembly; shut-off and strainer
ALL-S42	Low level wand adjustable to 42"
CKV-3/4PP	Back Check Valve
GF-NANO-M	NANO style glycol controller, single loop, buzzer
GF-XSG	XS glycol controller single loop
GF-XSH	XS glycol controller dual loop

Replacement plumbing assemblies can be ordered for glycol feeders by putting a prefix of **PA** in front of the glycol feeder model number (i.e. **PAGF-1A1A1A**). It will include isolation valves, pressure gauge, pressure relief valve and back check (the pressure transducer AGF-PTD is not included).

Economy Glycol Feeder

EGF glycol systems feed systems provide a compact wall-mountable tank with 30 GPD @ 100 PSI pump with prime function, 6-30 PSI switch, low level shut-off, pressure gauge, and 1/4 brass plumbing in one economical package.

EGF-05	5-gallon feeder with 30 GPD @ 100 PSI pump
EGF-10	10-gallon feeder with 30 GPD @ 100 PSI pump

Options

A2	240 volt no plug
B	15 GPD @ 150 PSI pump
C	Red pumping housing (instead of green)
C1	Blue pump housing (instead of green)
P	High pressure switch 20-120 PSI

Parts

SFS-SUCTION	Cutlet pump suction assembly	31.00
SFS-BV	Brass inlet ball valve	34.00
EGF-SWITCH30	6-30 psi pressure switch	93.00
EGF-SWITCH120	20-120 psi pressure switch	93.00
SFS-PG	0-100 psi gauge	29.00
EGF-LF-1	Low level switch	61.00
R00223	SS wall bracket for EGF-05	33.00

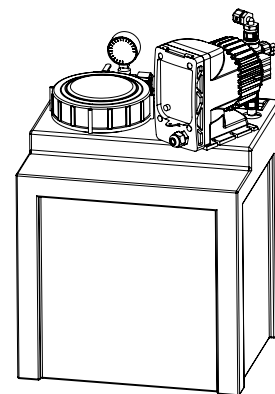

Bypass Feeders

Bypass Feeders are designed to provide a dependable means of introducing treatment chemicals into hot and cold water or other liquid streams with a large filtration capacity.

Bypass Feeders are rated to 300 PSI (20.7 bar) and 200°F (93.3°C). The coarse ACME thread cap design provides better sealing and quick opening.

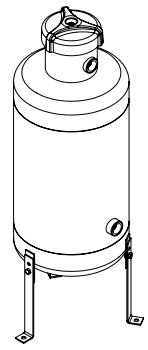

Model Number (Example: BF-05DX)

BF- _____

Capacity _____

- 02** = 2-gallon
- 05** = 5-gallon
- 12** = 12-gallon

Bottom _____

- D** = Dome with legs and bottom port
- F** = Flat

Filter _____

- X** = No filter
- 1** = 10" cartridge filter holder (20 micron hot filter included)
- 2** = 18" bag filter basket (25 micron bag included)
- 3** = 18" bag filter basket (5 micron bag included)
- 4** = 18" bag filter basket with no handle or filter

Accessory Kits

- BFK-ISOVALVES** = 3/4" brass isolation valves with unions and nipples
- BFK-DBDRAIN** = 3/4" brass drain valve and fittings for dome bottom
- BFK-FBDRAIN** = 3/4" brass drain valve and fittings for flat bottom
- BFK-GAUGEX** = 3/4" cross with 0-300 psi gauge, sample valve 180°F and fittings
- BFK-FUNASM** = 3/4" tee isolation valve and funnel

Parts

- BF-BAG0118** = 18" x 3" bag filter, 01 micron, 325°F
- BF-BAG0518** = 18" x 3" bag filter, 05 micron, 325°F
- BF-BAG2518** = 18" x 3" bag filter, 25 micron, 325°F
- BF-BGCAGE18** = Bypass feeder SS bag filter cage, 18"
- BF-BGCAGE18-F** = Bypass feeder SS bag filter cage, no handle
- BF-CF05-10** = 10" cold water cartridge filter, 05 micron, 120°F
- BF-CF20-10** = 10" cold water filter, 20 micron, 120°F
- BF-HF05-10** = 10" hot water cartridge filter, SS core, 05 micron, 200°F
- BF-HF20-10** = 10" hot water filter, SS core, 20 micron, 200°F
- BF-CFCAGE10** = Bypass feeder SS cartridge filter holder, 10"
- BF-CAP** = Bypass feeder cap assembly
- BF-FUNNEL** = Poly funnel with 3/4" MNPT
- BF-LEGS** = Bypass feeder leg kit
- BF-ORING** = Bypass feeder cap O-ring
- BF-PG** = 0-300 psi pressure gauge
- BF-PLATE** = Bypass feeder cap plate
- FLOW-2HT** = 3/4" flow indicator; 145 psi, 212°F max
- SFS-BV** = 1/4" brass bleed valve, 180°F max

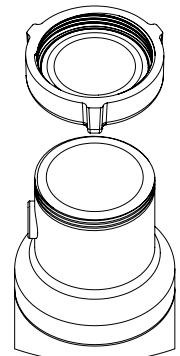

ACME cap

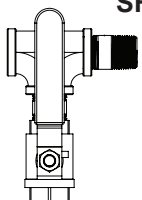

BFK-FBDRAIN

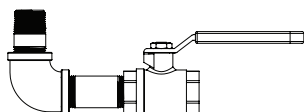

BFK-DBDRAIN

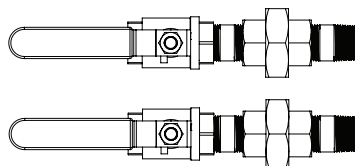

BFK-ISOVALVES

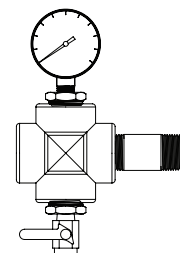

BFK-GAUGEX

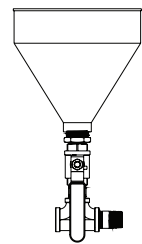

BFK-FUNASM

BOILER ACCESSORIES

Build Your Own Boiler Valve Package

With the AVP valve package, select the blowdown valve and flow restrictor that meets your boiler application's requirements and Advantage Controls will pre-assemble it with a probe cross (probe not included) to insure that you get a correct plumbing configuration.

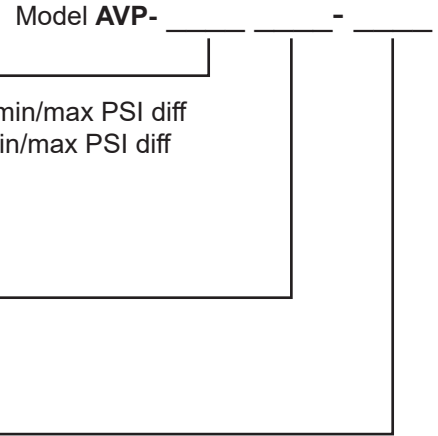
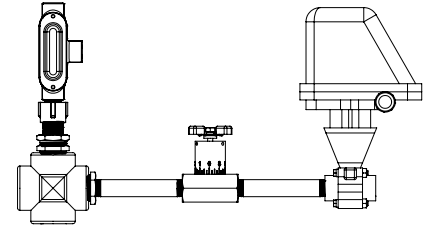

ELECTRIC BLOWDOWN VALVE

- 30 = MBWB-1/2 motorized ball valve SS, 360° actuator, 0-450 min/max PSI diff
- 40 = MBWA-1/2 motorized ball valve SS, 90° actuator, 0-450 min/max PSI diff
- 60 = SOB-1/2 brass solenoid valve, 0-140 min/max PSI diff

FLOW RESTRICTING DEVICE

- 00 = AOU-1 orifice union with 4 plates, 1000 PSI max
- 30 = NFC-1/2 flow control valve, 5000 PSI max

Options

- A Adds second flow restricting device for continuous sampling
- A1 Adds second NFC-1/2 in bypass plus a 3/4" flush valve
- C 3/4" probe tee instead of 1"
- F Add a 3/4" flush ball valve on bottom of probe cross (150 PSI max)
- Y1 Add 3/4" Y-strainer with flush valve before blowdown valve
- P Mount AVP and separately ordered controller onto poly board and pre-wire
- P1 Mount AVP and separately ordered controller & sample cooler onto poly board and pre-wire

Boiler Valve Stands

BVS boiler pre-fab systems include a MBWB-1/2 blowdown valve, NFC-1/2 throttling valve, 1" probe cross, 3/4" flush valve on bottom of cross, 1/2" blue poly panel (30"W x 16"H) for separately ordered controller, pre-wiring of probe and blowdown valve to controller, 6' tall powder coated steel legs with floor mounts.

BVS-30-30

Options

- B Bypass line with second NFC-1/2
- D Adds a second sample stream & valves
- C Continuous configuration w/ second NFC-1/2
- C1 Continuous configuration w/ second NFC-1/2 & MBWB-1/2
- K4 Plumbing right to left
- P 3/4" probe cross instead of 1" cross
- S Sample cooler (not pre-plumbed)
- L Second 1/2" blue poly panel on lower section

Notes:

1. If ordering a two sample stream stand and the bypass option (B) is desired, order it twice.

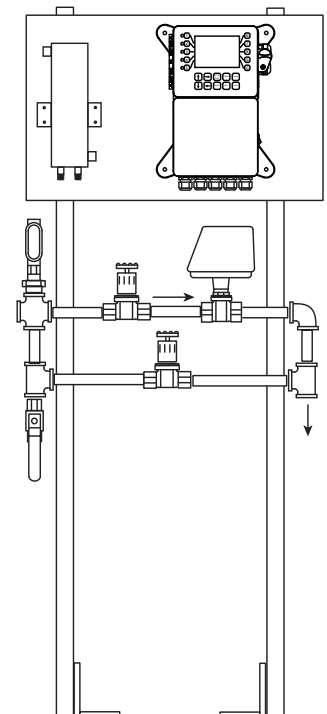

Boiler Trace Panels

Panels includes the following items mounted on a 1/2" blue poly panel:

- LBC-SS sample cooler
- Pressure relief valve on cooled sample
- NFC-1/2 throttling valve on boiler water inlet
- Non-electric sample temperature shut-off valve
PVC plumbing after the sample cooler is only rated to 100 PSI at 120°F
- Cold water inlet has no automatic valve, cold water will always run through sample cooler
- Desired controller and trace sensor to be ordered as separate line items
- Controller must have temperature / conductivity sensor for cooled trace sample line if operating electric valve on hot inlet

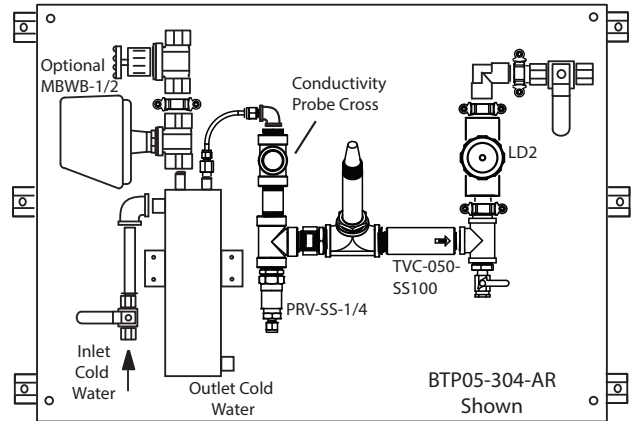

Model **BTP** _____ - _____ - _____

Board _____

- 00 = Plumbing only, no panel
- 05 = Board with no space for controller (32"H x 26"W)
- 10 = Board with space for controller (32"H x 38"W)

Inlet Boiler Water Valve Shut-Off _____

- X = No inlet sample shut-off
- 30 = MBWB-1/2 motorized ball valve (450 PSI max)
- 60 = SOB-1/2 solenoid valve (140 PSI max)
- 70 = SOB-1/2 solenoid valve on cooled sample outlet

Additional Probe Tees _____

- X = No cooled sample sensor tees
- 1 = One 3/4" SS conductivity probe tee, mounted vertical
- 2 = Two 3/4" PVC quick release probe tees, mounted horizontal
- 3 = Three 3/4" PVC quick release probe tees
- 4 = Two 3/4" SS tees
- 5 = Three 3/4" SS tees

Options _____

- A = Isolation valve on cold water inlet to sample cooler
- C = Cold water solenoid valve SO-1/2-P in inlet to sample cooler
- F = Low flow paddle switch in 3/4" PVC tee
- N = No temperature control valve
- R = Mounting rails
- S = Indicates BTP is to be mounted on separately ordered BVS prefab
- T = LD2 trace sensor tee only plugged (not needed if sensor is on order)
- T1 = Pyxis trace sensor tee only plugged (not needed if sensor is on order)
- U = 3/4" SS unions on both sides of trace sensor.
- W = Free standing legs

Boiler Solenoid Valves

SOB-1/2	1/2" Valve, 0-140 PSI, rated to 356°F
SOB-3/4	3/4" Valve, 0-140 PSI, rated to 356°F
SGB-1/2	1/2" Valve, 13-140 PSI, rated to 350°F
SGB-3/4	3/4" Valve, 13-140 PSI, rated to 350°F

Motorized Ball Valves, 0-450 PSI, Rated to 459° With 360° Electric Actuators

MBWB-1/2	1/2" Valve With 1036 Actuator
MBWB-3/4	3/4" Valve With 1036 Actuator
MBWB-1	1" Valve With 1036 Actuator

Motorized Ball Valves, 0-450 PSI, Rated to 459° With Heavy Duty 90° Electric Actuators

MBWA-1/2	1/2" Valve With 1075 Actuator
MBWA-3/4	3/4" Valve With 1075 Actuator
MBWA-1	1" Valve With 1075 Actuator

Motorized Ball Valve Parts

MWB	1036 Actuator Only
MWA	1075 Actuator Only
AWS-1/2	1/2" Valve Only, carbon steel body, 316 SS stem & ball
AWS-3/4	3/4" Valve Only, carbon steel body, 316 SS stem & ball
MWBS	Micro switch for activator

Boiler Rated Needle Control Valves with position indicator

NFC-1/2	1/2" 5,000 PSI
NFC-3/4	3/4" 5,000 PSI

Orifice Unions

AOU-1	1" Forged Steel Orifice Union with 4 Orifice Plates - 1,000 PSI
AOUP	Set of 4 Stainless Steel Orifice Plates Includes 1/8", 3/16", 1/4", 5/16" Orifice Sizes.
AOUP-1	1" Blank Plate, SS

Diverter Valves, Carbon Steel Body, Teflon Seals

MBWD-1/2	1/2" Consult Factory
MBWD-3/4	3/4" Consult Factory
MBWD-1	1" Consult Factory

Sample Coolers and Parts

LBC-SS	SS Sample Cooler With 316 SS Tubing, Tube & Connections Plain 1/4" OD Tube End (2500 PSI Hot Coil / 250 PSI on Cold Shell)
PRV-SS-1/4	1/4" SS pressure relief valve, relieves at 100 PSI
TCV-050-SS100	1/2" SS temperature control valve, closed at 110° F

Advantage Controls can help you source other valves and sizes not shown here. Consult factory for availability.

Specialty Sensors

Pyxis Fluorometer

Model **STA-** _____ - _____ - _____

Optics

- 500** = PTSA optics (0-300 ppb), CPVC, 100 psi
- 525** = Fluorescein optics (0-60 ppb), CPVC, 100 psi
- 730** = Turbidity optics (0-100 NTU), CPVC, 100 psi
- 730B** = Turbidity optics (0-500 NTU), CPVC, 100 psi
- 500SS** = PTSA optics (0-300 ppb), SS, 290 psi (no tee)
- 525SS** = Fluorescein optics (0-60 ppb), SS, 290 psi (no tee)

Wiring

- 1** = Standard 50" quick release cable with stripped ends
- 2** = 50" quick release cable pre-wired to separately order Advantage controller

Pre-Fab

- X** = Probe and tee not installed
- Y** = Probe and tee pre-installed in controller or prefab plumbing (must have Advantage controller or prefab ordered as separate line item on same order)

Parts & Accessories

PYXIS-T-N-PLUG	Pyxis PVC tee and plug is separately ordered controller or prefab
MA-WB	Bluetooth programming box with connectors
SP-350	Handheld PTSA only tester
SP-380	Handheld PTSA, Fluorescein tester
SP-400	Handheld PTSA and conductivity
SP-710	Handheld PTSA, pH, ORP, Cond, Temp, and total chlorine
SP-910	Handheld PTSA, Fluorescein and colorimeter
PTSA-100-P	100 ppb PTSA test solution, 500 ml
PTSA-300-P	300 ppb PTSA test solution, 500 ml
PTSA-1010-P	100ppb PTSA and 1,000 μ S/cm test solution, 500 ml
ST-SER-01	ST sensor cleaning kit and solution, 500 ml
FLUOR-50-P	50 ppb Fluorescein test solution, 500 ml
NTU-50-P	50 NTU test solution, 500 ml

Hand-held Simulator

The HanTron series of handheld signal simulators provide a convenient means of testing and calibrating multiple instrumentation signals, an efficient method for calibrating current loop devices, and simulating high impedance pH & ORP probe signals.

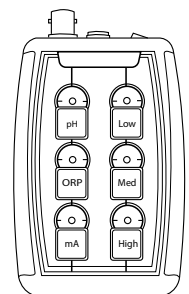

HT-SIM-MOP Signal simulator for calibrating and testing mA, pH, & ORP inputs

Options

- L** Adds mA cable with LD2 connector
- P** Adds mA cable with Pyxis connector

Parts

SIM-CABLE-BNC	Replacement BNC cable for simulator
SIM-CABLE-M	Replacement mA output cable for simulator
SIM-CABLE-LD2	Cable for mA output with LD2 connector
SIM-CABLE-PYX	Cable for mA output with PYXIS connector

 COND-PLUG-T3000	Conductivity test plug for MegaTron tower cards, 3,000 uS/cm
COND-PLUG-B7800	Conductivity test plug for boiler non-temp cards, 7,800 uS/cm

Little Dipper 2 Fluorometer by Turner Designs

Model **LD2820**

Optics

- A** = PTSA optics (0-300 ppb)
- F** = Fluorescein optics (0-100 ppb)

Wiring

- 1** = Standard 55" quick release cable with stripped ends
- 2** = 55" quick release cable pre-wired to separately order Advantage controller
- 3** = 72" quick release cable pre-wiring to separately order Advantage controller

Pre-Fab

- X** = Probe and tee not installed
- Y** = Probe and tee pre-installed in controller or prefab plumbing (must have Advantage controller or prefab ordered as separate line item on same order)
- Z** = Probe and tee pre-installed like option Y plus plug for tee

Parts and Accessories

LD2-CHECK-A	Hand held LD2 fluorometer with PTSA optics
LD2-CHECK-F	Hand held LD2 fluorometer with Fluorescein optics
OPTI-CHECK-2	Dual channel PTSA & Fluorescein Opti-Check tester
LD2-2820-505	Calibration cable and power supply
LD2-2820-510	Replacement tee and nut (1" FNPT)
LD2-021-2800	Replacement cable, 4-20mA; 62"
LD2-CABLE-180	Replacement cable, 4-20mA, 180"
LD2-CAL-T	Calibration tee with 1" FNPT plugs
LD2-O-ring	Replacement O-ring
LD2-PLUG	Plug for LD2 tee
LD2-RPK	Plumbing Kit to replace original tee (tee not included)
LD2-TMP	LD2 tee and plug installed in separately ordered prefab
PTSA-100	100 ppb PTSA test solution, 1 liter
PTSA-300	300 ppb PTSA test solution, 1 liter
FLUOR-100	100 ppb Fluorescein test solution, 1 liter

Pressure Reducing Flow Assembly for Fluorometer

Assembly includes 1/4" NPT inlet valve, low flow switch, pressure regulator, pressure gauge, 0-1 gpm flow indicator and 1/4" tubing to drain mounted on small blue panel. Order the desired sensor separately.

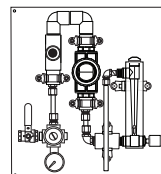

- PRFA-01-T** Flow assembly with Turner tee
- PRFA-01-P** Flow assembly with Pyxis tee

Free Chlorine & CLO2 Sensors

WG-FC02-ASM	0-2 PPM free chlorine sensor and flow assembly (flow cell, flow indicator, regulator, gauge and mounting board) 10 PSI max
WG-FC05-ASM	0-5 PPM free chlorine sensor and flow assembly (flow cell, flow indicator, regulator, gauge and mounting board) 10 PSI max
WGCLD02-ASM	0-2 PPM CLO2 sensor and flow assembly
WG-CLD10-ASM	0-10 PPM CLO2 sensor and flow assembly
WG-FC02	0-2 PPM free chlorine sensor only, 10 PSI and 0.2 GPM
WG-FC05	0-5 PPM free chlorine sensor only, 10 PSI and 0.2 GPM
WG-CLD02	0-2 PPM CLO2 sensor only, 10 PSI and 0.2 GPM
WG-CLD10	0-10 PPM CLO2 sensor only, 10 PSI and 0.2 GPM
WG-FL-ASM	Flow assembly and board without probe

Options

- H** Adds a sample cooler to flow assembly
- P** Adds PSDC-24 power supply & output wiring to controller
- M** Mounts separately-ordered controller on panel with sensor / no isolation valves

Replacement Parts

FLOW-25-01	0-1 GPM flow indicator with ¼" FNPT connections
SFS-PR	¼" FNPT pressure regulator
WG-FLOW	Flow tee only for WG sensors
WG-O-ring	O-ring for WG sensors
WG-FC-4015	Refill solution (two 30ml bottles)
WG-PG	0-30 PSI pressure gauge
WG-PTD	Pressure transducer 0-100 PSI
WG-FCLA-5017	3 polishing squares for cathode
WG-FCLA-5018	1 replacement cap and relief band, 2 refill solutions and syringes, 3 polishing squares



EchoPod Drum Level Sensors

DL 10-45-K	Pre-Calibrated to a 45" tall drum
DL 10-40-K	Pre-Calibrated to a 40" tall drum
DL 10-35-K	Pre-Calibrated to a 35" tall drum
DL 10-30-K	Pre-Calibrated to a 30" tall drum
DL 10-25-K	Pre-Calibrated to a 25" tall drum
DL 10-00-K	No pre-calibration 0-49"
DL 24-00-K	No pre-calibration 0-9.8'

Note: EchoPods require a 24 VDC supply like the PSDC-24-Q4 below.

EchoPod Parts

L199-2001	USB fob for programming
2C4A-116	Replacement 2" to 1" reducer bushing (new sensor includes one)
CABLE-FOB-7P	Cable to connect DL10/24's with K option to programming fob



LS200 Level Sensor



LS200- - -

Wiring

- 1 = 10' cable with stripped ends
- 2 = 10' cable pre-wired to Advantage device
- 3 = 12' cable with CABLE-7P-4 connector / stripped ends
- 4 = 12' cable with CABLE-7P-4 pre-wired to device

Bung Fitting

- X = Standard 1" MNPT threads
- B = MNPT adaptor added

Optical Leak Detection Sensor

LO10-1305	Optical leak sensor, PP, ¾" MNPT, 12-36 VDC powered with dry contact
------------------	--

DC Power Supply

PSDC-24	90-264 VAC to 24 VDC power supply (with USA cord)
----------------	---

Options

-A	No USA cord
-Q	Provides connections for 1-4 two-wire sensors (no cables)
-Q4	Provides connections for 4 two-wire sensors with 4 CABLE-7P-2, pre-wired

Tower Conductivity Replacement Probes

Quick Release Style

E-2-10	Non-Temperature Compensated Probe (A Minus Standard Replacement 10' cord)
E-3A-10	Probe, 3-wire with 10' Cord (Standard on original Analog Models)
E-4A-10	Probe, 4-wire with 10' cord (Standard Replacement MegaTron, MicroTrons and 2EZ)
E-4ASS-10	Stainless Steel electrodes, with 10' cord A Range Temperature Compensation

All quick release style conductivity probes are PVC..... 120 PSI (8.2 bar) @ 125°F (51.6°C)
For the probe and tee assembly add the "T" prefix.

Threaded Mount Probes

AH-4ASS	1" MNPT SS bushing, conductivity probe..... 250 PSI (17.2 bar) @ 140°F (60°C)
AH-4BSS	1" MNPT SS bushing, conductivity probe..... 250 PSI (17.2 bar) @ 140°F (60°C)

Special Type Probes

DC-4A	Tank mounted probe, CPVC..... 190°F (87.7°C)
DC-4ASS	Tank mounted, SS tips, CPVC..... 190°F (87.7°C)
CS-4ASS	Corporation stop probe, 1" valve PVC..... 75 PSI (5.1 bar) @ 140°F (60°C)
DI-4A	Direct insertion probe, 1" MNPT & quick release 120 PSI (8.2 bar) @ 125°F (51.6°C)
DI-27-4A	High conductivity probe with 1" quick release 120 PSI (8.2 bar) @ 125°F (51.6°C)
AL-4RTD	Pure water probe with RTD temp, ½" MNPT 100 PSI (6.8 bar) @ 212°F (100°C)
AL-4ASS-10	Pure water probe with thermistor, ½" MNPT 100 PSI (6.8 bar) @ 212°F (100°C)

Note: For conductivity probes with longer wires, see page 37.

Boiler Conductivity Replacement Probes

BE-2	1" MNPT SS threads, PEEK core 75 PSI (5.1 bar)
BE-32	1" MNPT SS, PEEK core 250 PSI (17.2 bar) @ 400°F (204°C) / 350 PSI @ 265°F
BE-32-S	¾" MNPT SS, PEEK core 250 PSI (17.2 bar) @ 400°F (204°C) / 350 PSI @ 265°F
BE-34B	1" MNPT SS PEEK, thermistor.. 250 PSI (17.2 bar) @ 400°F (204°C) / 350 PSI @ 265°F
BE-4RTD	1" MNPT SS, PEEK, RTD..... 250 PSI (17.2 bar) @ 400°F (204°C) / 350 PSI @ 265°F
BE-4RTD-S	¾" MNPT SS, PEEK, RTD..... 250 PSI (17.2 bar) @ 400°F (204°C) / 350 PSI @ 265°F
BE-H2-S	¾" MNPT SS, PEEK core 600 PSI (41.3 bar) @ 500°F (260°C)
BE-H4RTD-S	¾" MNPT SS, PEEK, 4-wire RTD..... 600 PSI (41.3 bar) @ 500°F (260°C)
1C	1" FNPT steel cross
3/4C	¾" FNPT steel cross for BE-4RTD-S Probe

- Notes:**
1. To make boiler probes a complete probe and cross assembly add a suffix of C to the end of the part number.
 2. **A** Range Temp Compensation = 32-140°F (0-60°C) **B** Range Temp Comp = 32-212°F (0-100°C)

pH Replacement Probes

PE-21	Flat Surface, PVC quick release, 10' lead 100 PSI (6.8 bar) @ 140°F (60°C)
PE-21SS	Double Junction, SS body, ½" MNPT 200 PSI (13.8 bar) @ 180°F (82.2°C)
PE-11	Low ionic pH 10' lead..... 50 PSI (3.4 bar) @ 180°F (82.2°C)
PE-21CS	Corp-stop pH sensor assembly, 1" FNPT..... 100 PSI (6.8 bar) @ 165°F (73.8°C)

ORP Replacement Probes

OE-21	Flat surface, PVC quick release, 10' lead..... 100 PSI (6.8 bar) @ 140°F (60°C)
OE-21SS	Double junction, SS body, ½" MNPT 200 PSI (13.8 bar) @ 180°F (82.2°C)
OE-11	Low ionic, ORP, 10' lead, ½" MNPT 50 PSI (3.4 bar) @ 180°F (82.2°C)
OE-21CS	Corp-stop ORP sensor assembly, 1" FNPT..... 100 PSI (6.8 bar) @ 180°F (82.2°C)

Temperature Only Replacement Probes

TC-1	Thermistor temperature probe, PVC quick release 120 PSI (8.2 bar) @ 125°F (51.6°C)
-------------	---

Plumbing Parts

BL-1	1" Non-Clear Flushable Basket Strainer (20 mesh screen)
BL-1-CL	1" Clear Basket Strainer
BL-3/4-BLK	3/4" Non-Clear Plastic Basket Strainer (20 mesh screen)
BL-3/4-BOWL	Bowl for BL-3/4
BL-3/4-GASKET	Gasket for BL-3/4
BL-3/4-SCREEN	Strainer screen for BL-3/4
FH-10-075	10" Filter housing 3/4" FNPT
GV-3/4	3/4" (200 PSI) Brass Ball Valve
PTS-3/4	3/4" Plastic Basket Strainer / Flushable
PTS-1.5	1-1/2" Plastic Basket Strainer / Flushable
TU-3/4	3/4" True Union PVC Ball Valve
TU-1	1" True Union PVC Ball Valve
Y STRAINER	3/4" Black Iron 20 Mesh Screen
YP-3/4	3/4" poly Y strainer, flushable (add -SP for flush valve)
AFS-1.5	1-1/2" basket strainer with 120 VAC powered flush valve

pH & ORP Probe Parts

BNC-ADPT	BNC to two-wire adaptor for pH/ORP probes
BNC-CONN	BNC connector for side of enclosure to system card
E-30-PH	O-ring (For New pH Probe)
FC-50P	1/2" MNPT gland for PE-11 probe
DPE	Tank Mounted pH/ORP Probe Assembly (less probe)
PE-NUT	Probe Assembly Nut
PH-EXT-10	pH Cable Extension, 10 feet
PH-EXT-50	pH Cable Extension, 50 feet
RTP-3	pH Transmitter with Power Supply and Multiple Wire Connections
RTP-4	pH Transmitter with replaceable batteries and 2 wire output
T-ADAPT	Quick disconnect pH/ORP probe opening to 1" slip adaptor

Miscellaneous PVC Quick Release Probe Assembly Parts

3/4 MNPT-KIT	2 PVC nipples, 3/4" male slip on one end and 3/4" male thread on the other end
T-3	Tee Only
T-3-CPV	CPVC Tee Only
PLUG-T3	Plug for T-3 tee complete with nut, O-ring and plug
MW-T-3	Single Probe Tee with 3/4" MNPT on one end and 3/4" slip on the other
MW-T-3-2	Dual Probe Tee assembly with 3/4" MNPT on one end and 3/4" slip on the other
INJ-COL	Injection tee collar
CAL-T3	Quick release 3/4" PVC tee plugged for holding calibration solution

Build a Replacement Flow Assembly (Probes not Included)

FS-	B1	Flow Switch Tee with Sample Tee Body
	B2	Add One Probe Tee
	B3	Add Two Probe Tees
	B6	Add Three Probe Tees
	0C -	Add Complete Flow Switch Cap and Plunger
	0C-P	Add paddle style flow switch and 1" PVC tee
	0C-I	Add Flow indicator with switch
	SP -	Add Plastic Sample Cock
	J1 -	Add 1 Injection Tee Assembly
	J2-	Add 2 Injection Tee Assemblies
	J3 -	Add 3 Injection Tee Assemblies
	J4 -	Add 4 Injection Tee Assemblies
FS-	B2	- 0C -
	SP	- J4
		U - Unassembled

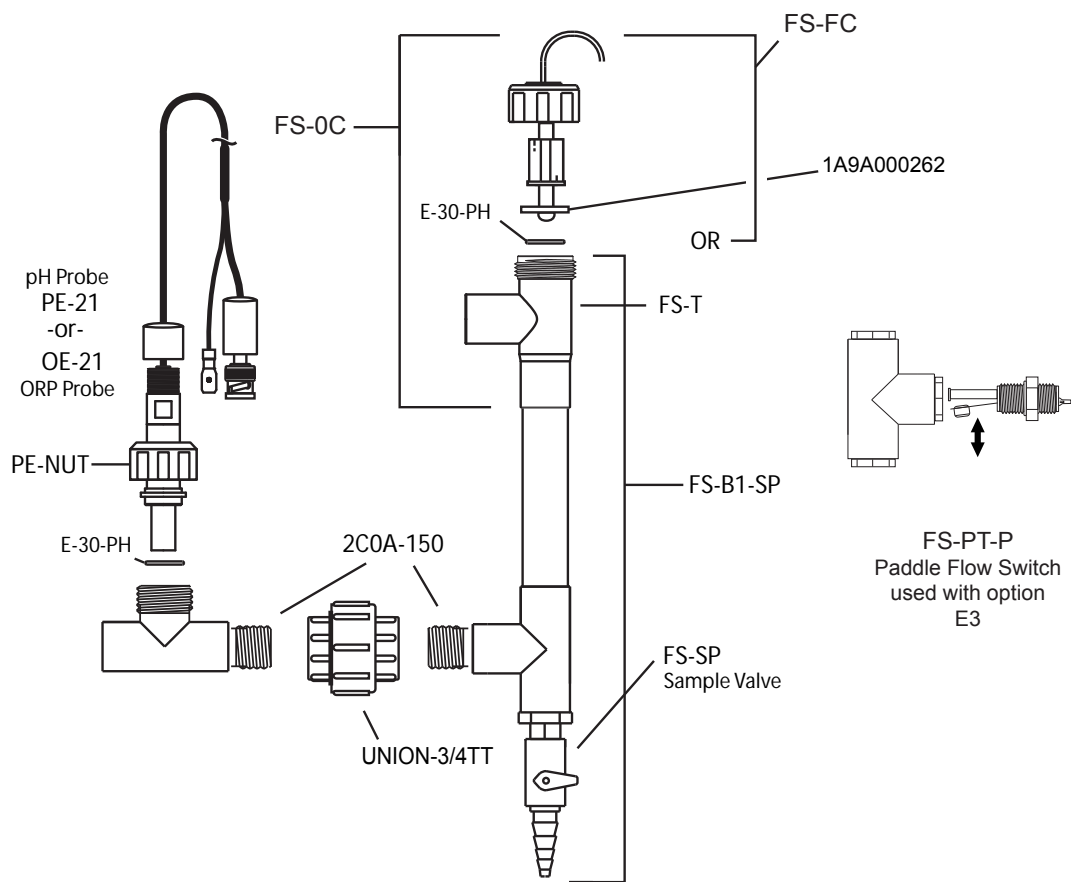

Flow Assembly Parts

- FS-C2** Dual read switch flow switch
- FS-CPV** Flow Switch - CPVC Cap and Reed Switch
- FS-0CPV** Complete CPVC Flow Switch Assembly
- FS-F2** Flow Switch - Gray Plunger and Magnet
- FS-FC** Flow Switch, PVC cap, reed switch, plunger, O-rings and float
- FS-SPRING** Spring for FS-C mechanical style flow switch
- FS-SP** Sample Ball Valve - PVC
- FS-T** Flow Switch - Clear PVC Tee (add G to get Gray)
- FS-0C** Complete Clear Flow Switch Assembly (add G to get Gray)
- FS-B1-SP** Flow switch and sample tee section
- E-30** O-ring for older quick release probes
- E-30-PH** O-ring for flow switch and quick release probes
- T-3** Probe Tee with 3/4" PVC slip connections in and out
- T-3E** 3/4" Tee With Sample Port
- MW-T-3** Single Probe Tee with 3/4" MNPT on one end and 3/4" slip on the other
- MW-T-3-2** Dual Probe Tee assembly with 3/4" MNPT on one end and 3/4" slip on the other
- MW-T-3-3** Triple Probe Tee assembly with 3/4" MNPT on one end and 3/4" slip on the other
- 2C0A-150** 3/4" slip to 3/4" MNPT nipple, PVC
- UNION-3/4TT** 3/4" PVC union, FNPT on both sides
- FS-HP-075** Flow Switch - High Pressure, Brass, 250 PSI @ 220°F, 3/4" tee
- FS-PT-P** Paddle type flow switch with 1" PVC tee with 3/4" reducers; 150 PSI @ 75°F
- FS-PT-P1** Paddle type flow switch with 1" PVC tee (no reducers)
- FS-PT** Paddle type flow switch (no tee).
- FS-LF-P-075** 3/4" low flow paddle switch with 3/4" PVC slip tee (0.4 GPM on)
- FS-PT-CAP** Black cap for FS-PT style flow switches
- FS-PT-075** 3/4" MNPT paddle switch
- FS-PT-B-075** 3/4" MNPT paddle switch with 3/4" brass tee
- FS-PT-S-075** 3/4" MNPT paddle switch with 3/4" iron tee
- 1A9A000262** Flow director for new style flow switch
- T-FS-PT** 1" PVC tee for FS-PT

Filter Housings

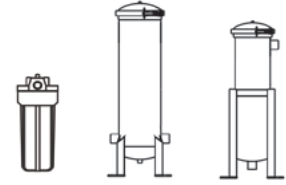
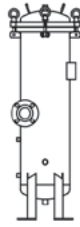

SCICLONE Series 304SS Housing with Solid Separation before Jumbo Filter

Part	Description	Ports	Drain	Flow
SC40SB	40 single jumbo filter	2" Flange	3/4" FNPT	50 gpm
SC90SB	90 single jumbo filter	2" Flange	3/4" FNPT	100 gpm
SC170SB	170 single jumbo filter	2" Flange	3/4" FNPT	150 gpm
SC170SB-3	170 x 3 single jumbo filter	4" Flange	1.5" FNPT	450 gpm
SC170SB-4	170 x 4 single jumbo filter	6" Flange	1.5" FNPT	600 gpm

HSBJ Series Jumbo 304 SS Filter Housing with Swing Bolts

Part	Description	Ports	Drain	Flow
HSBJ40	40 single jumbo filter	2" FNPT	1" FNPT	50 gpm
HSBJ90	90 single jumbo filter	2" FNPT	1" FNPT	100 gpm
HSBJ170	170 single jumbo filter	2" FNPT	1" FNPT	150 gpm
HSBJ170SB-3	170 x 3 single jumbo filter	4" FNPT	1.5" FNPT	450 gpm
HSBJ170SB-4	170 x 4 single jumbo filter	6" FNPT	1.5" FNPT	600 gpm

HBCJ Series Jumbo 304 SS Filter Housing with Band Clamp

Part	Description	Ports	Drain	Flow
HBCJ40	40 single jumbo filter	2" FNPT	1" FNPT	50 gpm
HBCJ90	90 single jumbo filter	2" FNPT	1" FNPT	100 gpm
HBCJ170	170 single jumbo filter	2" FNPT	1" FNPT	150 gpm

MRH Series 2.75" Multi Round 304SS Filter Housing with Band Clamp

Part	Description	Ports	Drain	Flow
MRH-410-2BC	4 x 10" single 2.75" filters	2" FNPT	3/4" FNPT	28 gpm
MRH-420-2BC	4 x 20" single 2.75" filters	2" FNPT	3/4" FNPT	56 gpm
MRH-510-2BC	5 x 10" single 2.75" filters	2" FNPT	3/4" FNPT	35 gpm
MRH-520-2BC	5 x 20" single 2.75" filters	2" FNPT	3/4" FNPT	70 gpm
MRH-530-2BC	5 x 30" single 2.75" filters	2" FNPT	3/4" FNPT	105 gpm
MRH-540-2BC	5 x 40" single 2.75" filters	2" FNPT	3/4" FNPT	140 gpm

BF Series Bag Filter Housing 304SS with Adjustable Legs

Part	Description	Ports	Vents	Flow
BF1-304-2NBC	1 x #1 bag, band clamp	2" FNPT	1/4" FNPT	90 gpm
BF2-304-2NBC	1 x #2 bag, band clamp	2" FNPT	1/4" FNPT	180 gpm
BF1-304-2N	1 x #1 bag, swing bolt	2" FNPT	1/4" FNPT	90 gpm
BF2-304-2N	1 x #2 bag, swing bolt	2" FNPT	1/4" FNPT	180 gpm

BF Series Bag Filter Housing Carbon Steel with Adjustable Legs

Part	Description	Ports	Vents	Flow
BF1-C-2N	1 x #1 bag, swing bolt	2" FNPT	1/4" FNPT	90 gpm
BF2-C-2N	1 x #2 bag, swing bolt	2" FNPT	1/4" FNPT	180 gpm

2.5" O.D. Filter Housing 125F AND 100 PSI Max

HF5-10BLBK34PR	10" Blue Body, 3/4" Black Rib Cap, PR
HF5-10CLBK34PR	10" Clear Body, 3/4" Black Rib Cap, PR
HF5-ORING	O-ring for HF5 Filter Housing
FM-20W	Bracket White, Single HF5

4.5" O.D. Filter Housing 100F and 90 PSI Max

HF45-10BLBK34PR	10" Blue 4.5" Body, 3/4" Black Cap, PR
HF45-10CLBK34PR	10" Clear 4.5" Body, Black Cap 3/4", PR
HF45-20BLBK10PR	20" Blue 4.5" Body, 1" Black Cap, PR
HF45-20CLBK10PR	20" Clear 4.5" Body, Black Cap 1" PR
HF45-ORING	O-ring for HF45 Filter Housing
FM-25W	Bracket White, Single HF45 4.5" O.D. Housing

Hot Water 2.5" Filter Housings

HF5HT-10RDRD34	10" Red plastic, 165°F max
HF4510SS-10	10" 304 SS housing, 200°F max

Replacement Filters



Polypropylene Bag Filters for BF housings Max Temp 190°F

Part	Description	Micron	Case
BAG1-5M	#1 bag, 7" x 16.5"	5 μ	50 pcs
BAG1-25M	#1 bag, 7" x 16.5"	25 μ	50 pcs
BAG1-50M	#1 bag, 7" x 16.5"	50 μ	50 pcs
BAG1-75M	#1 bag, 7" x 16.5"	75 μ	50 pcs
BAG2-5M	#2 bag, 7" x 32"	5 μ	50 pcs
BAG2-25M	#2 bag, 7" x 32"	25 μ	50 pcs
BAG2-50M	#2 bag, 7" x 32"	50 μ	50 pcs
BAG2-75M	#2 bag, 7" x 32"	75 μ	50 pcs

SPX Series 2.75" Pleated Poly Filters with Poly Core, Max Temp 140°F

SPX-275-1005	2.75" round x 9.75" long	5 μ	40 pcs
SPX-275-1020	2.75" round x 9.75" long	20 μ	40 pcs
SPX-275-1050	2.75" round x 9.75" long	50 μ	40 pcs
SPX-275-19505	2.75" round x 19.5" long	5 μ	20 pcs
SPX-275-19520	2.75" round x 19.5" long	20 μ	20 pcs
SPX-275-19550	2.75" round x 19.5" long	50 μ	20 pcs

SPX Series 4.5" Pleated Poly Filters with Poly Core, Max Temp 140°F

SPX-45-1005	4.5" round x 9.75" long	5 μ	12 pcs
SPX-45-1020	4.5" round x 9.75" long	20 μ	12 pcs
SPX-45-1050	4.5" round x 9.75" long	50 μ	12 pcs
SPX-45-2005	4.5" round x 20" long	5 μ	6 pcs
SPX-45-2020	4.5" round x 20" long	20 μ	6 pcs
SPX-45-2050	4.5" round x 20" long	50 μ	6 pcs

SWX Series 2.5" String Wound Poly Filters with Poly Core, Max Temp 140°F

SWX-25-1005	2.5" round x 10" long	5 μ	40 pcs
SWX-25-1020	2.5" round x 10" long	20 μ	40 pcs
SWX-25-1050	2.5" round x 10" long	50 μ	40 pcs
SWX-25-2005	2.5" round x 20" long	5 μ	20 pcs
SWX-25-2020	2.5" round x 20" long	20 μ	20 pcs
SWX-25-2050	2.5" round x 20" long	50 μ	20 pcs

SWT Series 2.5" String Wound Poly Filters with Tin Core, Max Temp 200°F

SWT-25-1005	2.5" round x 10" long	5 μ	40 pcs
SWT-25-1010	2.5" round x 10" long	10 μ	30 pcs
SWT-25-1020	2.5" round x 10" long	20 μ	40 pcs
SWT-25-1050	2.5" round x 10" long	50 μ	40 pcs
SWT-25-2005	2.5" round x 20" long	5 μ	20 pcs
SWT-25-2020	2.5" round x 20" long	20 μ	20 pcs
SWT-25-2050	2.5" round x 20" long	50 μ	20 pcs

HSC Series Pleated Jumbo Cartridges for Sciclone, HSBJ and HBCJ, Max Temp 140°F

Part	Dimensions	Micron	Rcmd Flow	Max Flow
HSC-40-10	7 3/4" x 9 5/8"	10 μ	35 gpm	50 gpm
HSC-40-50	7 3/4" x 9 5/8"	50 μ	35 gpm	50 gpm
HSC-40-100	7 3/4" x 9 5/8"	100 μ	35 gpm	50 gpm
HSC-90-10	7 3/4" x 19 1/2"	10 μ	70 gpm	100 gpm
HSC-90-50	7 3/4" x 19 1/2"	50 μ	70 gpm	100 gpm
HSC-90-100	7 3/4" x 19 1/2"	100 μ	70 gpm	100 gpm
HSC-170-10	7 3/4" x 30 3/4"	10 μ	105 gpm	150 gpm
HSC-170-50	7 3/4" x 30 3/4"	50 μ	105 gpm	150 gpm
HSC-170-100	7 3/4" x 30 3/4"	100 μ	105 gpm	150 gpm

Accessories

FBK-ISOVALVES	Two 304SS 2" ball valves and 3" long nipples for filter housings with 2" ports
FPTD-100	Two-wire 0-100 psi pressure transducer 4-20 mA out
PG25100B	2.5" pressure gauge, backmount, 1/4" MNPT 0-100 psi
PG25160B	2.5" pressure gauge, backmount, 1/4" MNPT 0-160 psi
PG25300B	2.5" pressure gauge, backmount, 1/4" MNPT 0-300 psi

Cell Advantage (cell router & service)

Model ROUTER - -

Router Type

- 3 = Industrial grade with built in modem
- 3A = Industrial grade with build in modem for AT&T
- 4 = Industrial grade with built in modem with international power adapters

Prepaid Cell Service

- 00 = No service (also removes the USB modem)
- 12 = 1 GB/ Month data for 12 months
- 12S = 1 GB/Month data for 12 months w/ delayed activation
- 24 = 1 GB/Month data for 24 months

Parts

- VDATA-12 1 GB/ Month data for 12 months
- VDATA-24 1 GB/ Month data for 24 months
- R-ROUTER-3 Replacement industrial grade router only; no enclosure
- ROUTER-ANTENNA Replacement magnetic mount antenna for ROUTER-3
- ROUTER-PBOX Install router power transformer in NANO box with 120 VAC cord
- ROUTER-SWITCH-4 External ethernet switch (4 port)

Hand Held Tester

The HanTron series of handheld testers provide accurate conductivity and temperature readings of any water system sample with features normally seen on much more expensive testers including: memory for 20 readings, unit of measure selections, and temperature readings at a price comparable to older analog testers.

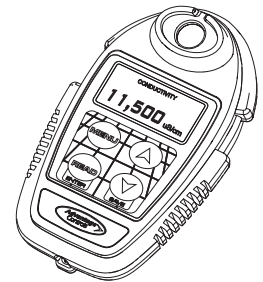

HT-3P = Conductivity tester

Standard Solutions

CONDUCTIVITY

- C-500-16 500 μ S 16 oz.
- C-2500-16 2500 μ S 16 oz.
- CAL3PK-COND 4 oz of 148, 3482 & 12880 conductivity standards

pH

- pH-4-16 4.0 pH 16 oz.
- pH-7-16 7.0 pH 16 oz.
- pH-10-16 10.0 pH 16 oz.

ORP

- ORP-16 200-275 mV ORP 16 oz.

Liquid Level Alarm Fill Controllers

ALL low-level units prevent pumps from running dry and provide an alarm LED and relay notification of the low-level condition.

FILL units automate filling of a tank with a low “ON” and high “OFF” level switch input.

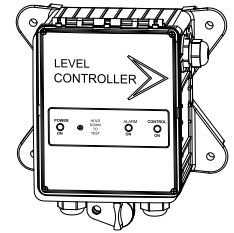

ALL-100	Designed for use with 100-gallon tank. Level controller with 60” wand 120 VAC, 60 Hz, 5-amp receptacles labeled PUMP and ALARM
ALL-50	Designed for use with 50-gallon tank. Level controller with 42” wand 120 VAC, 60 Hz, 5-amp receptacles labeled PUMP and ALARM
ALL-30	Designed for use with 30-gallon tank. Level controller with 30” wand 120 VAC, 60 Hz, 5-amp receptacles labeled PUMP and ALARM
ALL-C	Level Controller only (less wand)
FILL-C00	Fill controller only with no level wands
FILL-C35	Fill controller only with 2 wands sized for an Advantage 35-gallon tank
FILL-C55	Fill controller only with 2 wands sized for an Advantage 55-gallon tank

Options

C	240 V
E	Extra Output Cord
H	High alarm input on FILL unit with control cut-off and 120-volt alarm output (no wand)
H1	High alarm on FILL unit with control cut-off and dry contact alarm output (no wand)
LED	LED on Level Wand
S	Switch for Output (ON/OFF)
V	Audible Alarm with Silence Switch, 100 db

Level Wands Only

ALL-S60	Level Wand adjustable to 60” with switch contacts 28 VDC 50 mA
ALL-S42	Level Wand adjustable to 42” with switch contacts 28 VDC 50 mA
ALL-S30	Level Wand adjustable to 30” with switch contacts 28 VDC 50 mA
ALL-S20	Level Wand adjustable to 20” with switch contacts 28 VDC 50 mA
ALL-S12	Level Wand adjustable to 12” with switch contacts 28 VDC 50 mA
A	CPVC construction instead of PVC
C	Prewire Level Wand to separately ordered MegaTron
D	Level wand ¼” pipe with second liquid tight for suction tubing

Standard Wire Extensions for Conductivity and Flow Sensors

WIRE-2-10C	2 conductor, 10’ extension
WIRE-2-25C	2 conductor, 25’ extension
WIRE-2-50C	2 conductor, 50’ extension
WIRE-2-100C	2 conductor, 100’ extension
WIRE-4-10C	4 conductor, 10’ extension
WIRE-4-25C	4 conductor, 25’ extension
WIRE-4-50C	4 conductor, 50’ extension
WIRE-4-100C	4 conductor, 100’ extension

Add an R to the end of the part number for Molex connection.

Note: Order controller with standard probe wire and the extension(s) desired as a separate line item. The probe wire extension will be added to the controller as a continuous length.

WIRE-2	2 Conductor Cable - 22 AWG	2.00/ft
WIRE-3	3 Conductor Cable - 22 AWG	3.00/ft
WIRE-4	4 Conductor Cable - 22 AWG	3.00/ft
WIRE-DUCT	1” x 1” wire channel duct with cover	7.50/ft

CABLE-7P-2	Prewired 2 conductor cable to mA input and 12VDC power with 7 pin connector, 6’
CABLE-7P-4	Prewired 4 conductor cable to mA input and 12VDC power with 7 pin connector, 6’
CABLE-7P-2A	Prewired 2 conductor cable to mA input and no voltage and 7 pin connector, 6’
CABLE-7P-EXT25	25’ extension cable with connectors
CABLE-7P-EXT50	50’ extension cable with connectors

Note: Add -15 to the end of CABLE part number for 15’ long cable.

Miscellaneous

BOXFLOWCLIP-1	Flow clip assembly for SS/XS controllers
BOXFLOWCLIP-75	Flow clip assembly for MicroTron and 2EZ controllers
BUZZ-1	Alarm buzzer (100 db) in standard box, pre-wired with 8' male power cord (-2, -3 or -4 for addition power cord inputs)
CIRC-075	3/4" Circ pump; 4 GPM, 120 VAC pre-wired
CIRC-075-SS	3/4" Circ pump stainless steel; 10 GPM, 100 PSI, 120 VAC pre-wired
CLAMP-ASM-3/4A	Adjustable pipe clamp assembly with bolts and t-nuts
CLIP-3/4-ASM	3/4" pipe mounting C clip with base
CLIP-1-ASM	1" pipe mounting C clip with base
CORD-POWER	Power Cord -8 foot with plug
CORD-RECPT	8" cord with Molded Receptacle
DOOR	Clear Lexan cover for enclosure (SS, XS, Micro & 2EZ Controllers)
DOOR-Z	Black cover for SS, XS, Micro, 2EZ & NANO option W Controllers
KEY-FE3	Replacement key for FE3 cabinet
MA-LOOP-ISO-1	4-20mA loop isolator
MG-COVER	Lower cover on MegaTron full size units
MICRO-BOX	New style MicroTron box with clear cover
MICRO-KEYPAD	Replacement keypad for MICRO-C/F4
MINI-BUZZ	Alarm buzzer in mini box with plug in transformer, 100 db
MS-001	Motor Starter, 25 Amp Relay, conduit connections
MS-002	Motor Starter, 25 Amp Relay, prewired (2 male, 1 female, 13-amp cords)
MS-003	25-amp relay box, 120 pre-wired input with 2 wire dry contact output
MS-003-001	Mounts a MS-003 on poly with separately ordered NANO-F2
NANO-BOX-3	Nanotron style box with cover and 3 liquid tight 3/8"
P6MC4	1/4" MNPT to 3/8" tubing, straight
PRV-SS-1/4	1/4" SS pressure relief valve, relieves at 100 PSI
PTD-025	0-25 PSI pressure transducer, 4-20 mA out, 12-24 VDC
SS-CMB	3/8" poly panel for mounting SS with no plumbing area
SS-COVER	Lower cover on SS & XS enclosures
SS-LATCH	Replacement latch for SS, MicroTron and analog units
SS-MIDSECTION	Middle section of SS & XS enclosure
1A0A000078	MG/SS battery
1A1T000084	NANO battery
1A5B000337	Relay output Fuse 5 x 20 MM, 5 AMP
1A9A000015	1/2" liquid tight
1A9A000017	3/8" liquid tight
1A9A000243A	3/8" liquid tight to 1/2" FNPT conduit
1G1F000087	20-amp relay, 230 VAC
1G1F000105	25-amp relay
1M1P000043	120 VAC plugin AC adapter; 24 VDC out
1M1P000159	XS battery
1P1P000219	Relay output Fuse 5 x 20 mm, 2.5 AMP slow blow

MegaTron Parts

MG-RL-CPLR	Relay card ribbon cable to wire cable adapter inside controller
MG-RL-CPLR-EXT	Relay card adapter for remote relay box
MG-PWR	Power supply board
MG-PROGCHIP	MegaTron Program chip
MG-KEYPAD-ASM	Keypad and display panel assembly (no display)
MG-DISPLAY-ASM	Display panel assembly complete with keypad
MG-DISPLAY-ASM-V1	Display panel assembly complete with keypad (older motherboards)
MG-DOOR	Clear cover
MG-FUSE-PAK	(5) 2.5-amp fuses
MG-ICM-01	Internet communications card
MG-CAT5	CAT 5 cable from internal communications card
MG-MAO-3	4-20mA output card with 3 outputs
MG-MAO-6	4-20mA output card with 6 outputs
MG-MAI-3	4-20mA input card with 3 inputs
MG-MAI-8	4-20mA input card with 8 inputs
MG-AUXFLOW-W3	3 auxiliary flow meter inputs
MG-AUXFLOW-W6	6 auxiliary flow meter inputs
MG-AUXFLOW-W9	10 auxiliary flow meter inputs
AUXFLOW-WIRE	Auxiliary flow meter input cable with 3 pin Molex
MG-SYS-	System card
	Add all the desired system function codes from the unit model numbering system.

Repair Options and Fees

Advantage Controls is proud to offer a two-year warranty on all controllers and metering pumps. We back this warranty up with a unique 30-day replacement memo policy. If something happens to your unit after it is out-of-warranty, we still want to help.

Call our technical support staff with the model, serial number and problem of your unit. If we are unable to fix the unit through troubleshooting, we will give you an RMA (return materials authorization) number to send the unit in. The different styles of units (Megatron, MICROtron, Nanotron controllers and pump) each have a Repair List Price. Normal replacement items are not included (i.e. probes, flow switches, liquid ends)

HT-3P

Analog Timers, Liquid Level and Flow Controllers

MicroTron Controllers (with 1 or less probe inputs)

MicroTron Controllers (with 2 or more probe inputs)

MegaTron MG

MegaTron MT

MegaTron XS

NanoTron timer only

NanoTron (1 sensor input)

Pumps (does not include liquid-end parts)

Service Call

Consult factory for more details.

Manufacturer's Product Warranty

Advantage Controls warrants control systems of its manufacture to be free of defects in material or workmanship. Liability under this policy extends for 24 months from date of installation (sensors are not included). Liability is limited to repair or replacement of any failed equipment or part proven defective in material or workmanship upon manufacturer's examination. Removal and installation costs are not included under this warranty. Manufacturer's liability shall never exceed the selling price of equipment or part in question. Advantage disclaims all liability for damage caused by its products by improper installation, maintenance, use or attempts to operate products beyond their intended functionality, intentionally or otherwise, or any unauthorized repair. Advantage is not responsible for damages, injuries or expense incurred through the use of its products. The above warranty is in lieu of other warranties, either expressed or implied. No agent of ours is authorized to provide any warranty other than the above.

30 Day Billing Memo Policy

Advantage Controls maintains a unique factory exchange program to ensure uninterrupted service with minimum downtime. If your controller malfunctions, call 1-918-686-6211 (international customers dial +1918 686-6211), and provide our technician with Model and Serial Number information. If he is unable to diagnose and solve your problem over the phone, a fully warranted replacement unit will be shipped, usually within 48 hours, on a 30-Day Billing Memo. This service requires a purchase order, and the replacement unit is billed to your regular account for payment. The replacement unit will be billed at current list price for that model less any applicable resale discount. Upon return of your old unit, credit will be issued to your account if the unit is in warranty. If the unit is out of warranty or the damage not covered, a partial credit will be applied based upon a prorated replacement price schedule dependent on the age of the unit. Any exchange covers only the controller or pump. Electrodes and other external accessories are not included.

Get the Advantage in Water Treatment Equipment

Advantage Controls can give you the *Advantage* in products, knowledge and support on all of your water treatment equipment needs.

- Cooling Tower Controllers
- Boiler Blow Down Controllers
- Blow Down Valve Packages
- Bleed Valves
- Water Meters
- Chemical Metering Pumps
- Corrosion Coupon Racks
- Chemical Solution Tanks
- Solid Feed Systems
- Bypass Feeders
- Filter Equipment
- Glycol Feed Systems
- Pre Fabricated Systems

